



World Para  
**Ice Hockey**

World Para Ice Hockey

# Rules 2018-2022

October 2018



[www.WorldParalceHockey.org](http://www.WorldParalceHockey.org)

 [@ParalceHockey](https://twitter.com/ParalceHockey)

 [@ParalceHockey](https://www.instagram.com/ParalceHockey)

 [/ParalceHockey](https://www.facebook.com/ParalceHockey)

 [ParalympicSport.TV](https://www.youtube.com/ParalympicSport.TV)



# World Para Ice Hockey Rulebook

2018-2022

October 2018

**World Para Ice Hockey**

Adenauerallee 212-214  
53113 Bonn, Germany  
[www.WorldParaIceHockey.org](http://www.WorldParaIceHockey.org)

Tel. +49 228 2097-149  
Fax +49 228 2097-209  
[info@worldparaicehockey.org](mailto:info@worldparaicehockey.org)



## 1 Introduction

100 This WPIH Rulebook contains the playing rules for the sport of Para ice hockey.

a) The rules in this WPIH Rulebook are mandatory for all Recognised Competitions.

b) All participants (including, but not limited to, athletes and athlete support personnel, coaches, trainers, managers, interpreters, team staff, officials, medical or paramedical personnel) of any Recognised Competitions agree to be bound by the rules in this WPIH Rulebook as a condition of such participation.

c) The IPC Handbook is an integral part of the governance of the sport of Para ice hockey.

d) Any matter not addressed in this WPIH Rulebook, or in the Regulations, will be determined by the IPC, in its sole discretion.

e) This WPIH Rulebook will be effective from 1 October 2018.

f) WPIH may amend the WPIH Rulebook from time to time. Such amendments will come into effect on the date specified by WPIH.

g) Capitalised terms used in this WPIH Rulebook have the meanings given to them in the Regulations (unless otherwise defined).

h) This WPIH Rulebook is the copyright property of the IPC and has been published for the benefit of NPCs, NFs, athletes, officials and others who are engaged in an official capacity with World Para Ice Hockey. This WPIH Rulebook or any part of it may be reprinted or translated by any organisation with a legitimate need to do so, subject to IPC's continuing ability to assert its copyright in the WPIH Rulebook, including the right to insist on an assignment to the IPC of the copyright in any translated version of the WPIH Rulebook. Any other organisation must obtain the permission of the IPC prior to reprinting, translating or publishing the WPIH Rulebook.

i) The English version of this WPIH Rulebook will be accepted as the authoritative version for the purpose of interpretation.

j) Violations of these rules are dealt with during game action by on-ice officials. More serious violations may be further addressed after the game by proper authorities in accordance with this WPIH Rulebook, the WPIH Regulations and/or other relevant IPC rules and regulations.

## 2 Field of play specifications

### 200 Definition of the field of play

The game of Para ice hockey shall be played on a white ice surface known as a rink (Figure 2).

### 201 Dimensions of the rink

Maximum size: **61m** long by **30m** wide.

Minimum size: **56m** long by **26m** wide.

The corners shall be rounded in the arc of a circle with a radius of **7m** to **8.5m**.

### 202 Boards

The rink shall be surrounded by a wooden or plastic wall known as the boards, which shall be white in colour.

The height of the boards should be **107cm** from the ice surface.

The boards shall be constructed in such a manner that the surface facing the ice shall be smooth and free of any obstruction that could cause injury to the players and the protective screens and gear used to hold the boards in position shall be mounted on the side away from the playing surface.

The gaps between the panels shall be minimized to **3mm**.

### 203 Kick plate

At the lower part of the boards a kick plate will be fixed, yellow in colour, **15cm** to **25cm** in height.

### 204 Benches

Team benches and penalty boxes must have plexiglass in front (Figure 1); the team benches must have two doors with level access to the ice surface. Allowing the athletes entrance and egress without assistance or lifting by support staff. The penalty boxes should have level access also. Additionally, the surfaces inside these off-ice areas should be covered with plastic-ice or other material to avoid damage to sledge blades. Any structural supports protruding must be securely padded or protected to avoid damage or injury.

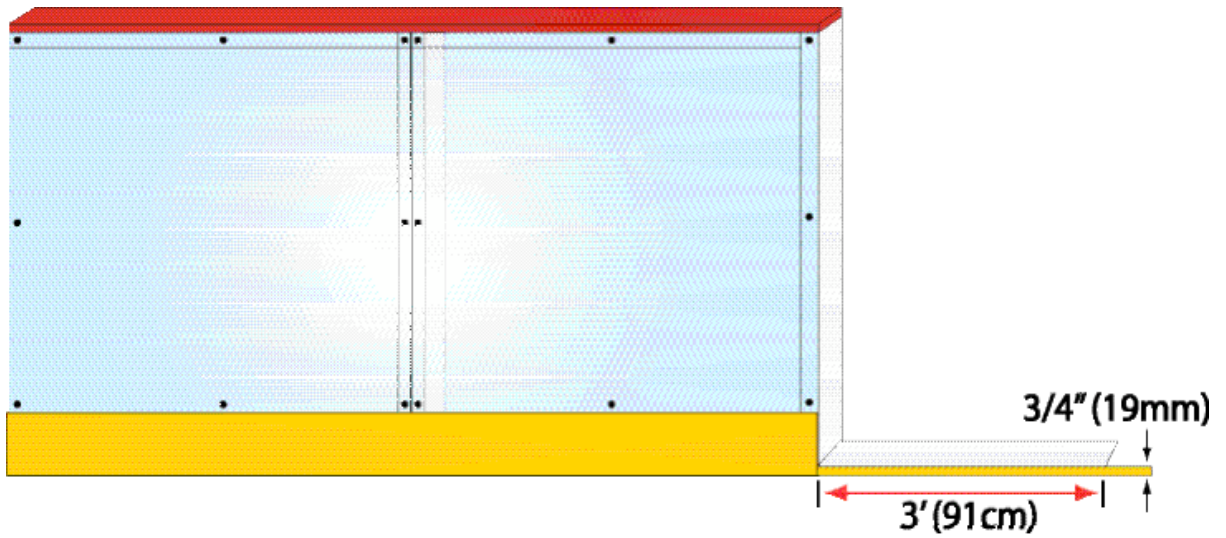

*Figure 1: Boards with plexiglass, width of the doors and height of the kick plate at the doors.*

Ice rink

NEW

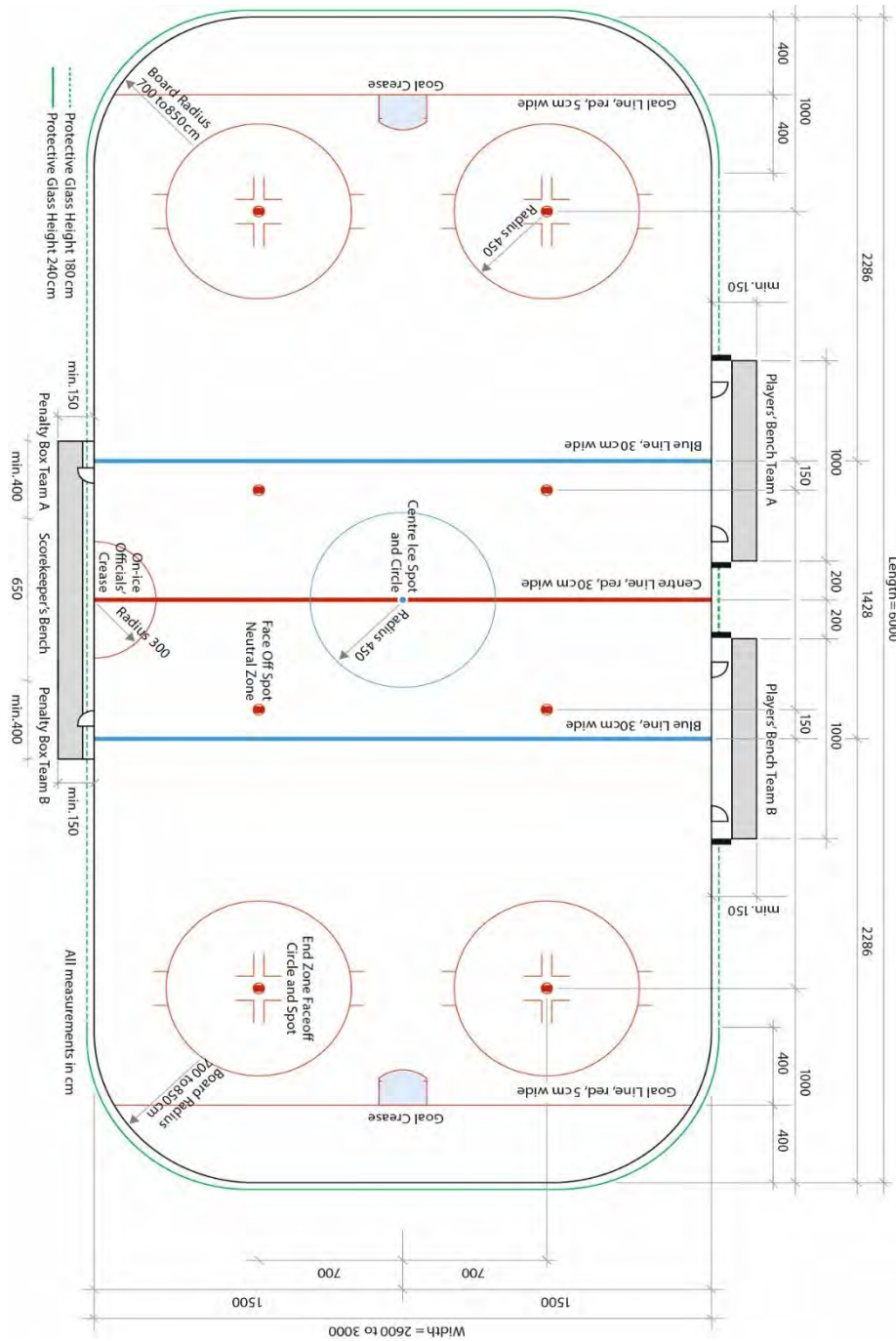

Figure 2: Ice rink. This diagram is used with the permission of IIHF.

## 205 Doors

- a) All doors giving access to the ice surface must swing away from the ice surface.
- b) The gaps between the door and the board shall be minimized to 5mm.

## 206 Protective glass

- a) The protective glass (Figure 3) located above the boards shall be 160cm to 200cm in height on the ends and shall extend 4m from the goal line towards the neutral zone, and not less than 80cm in height along the sides, except in front of the team benches.
- b) The gaps between the glass panels shall be minimized to 5mm.
- c) At any interruption of the protective glass there shall be protective padding to prevent the injury of the players.
- d) No openings are allowed in the protective glass. In case of advertising allowed on the boards, the lines shall at least be marked on the kick plate. The entire width of the line shall be considered as part of the zone that the puck is in.

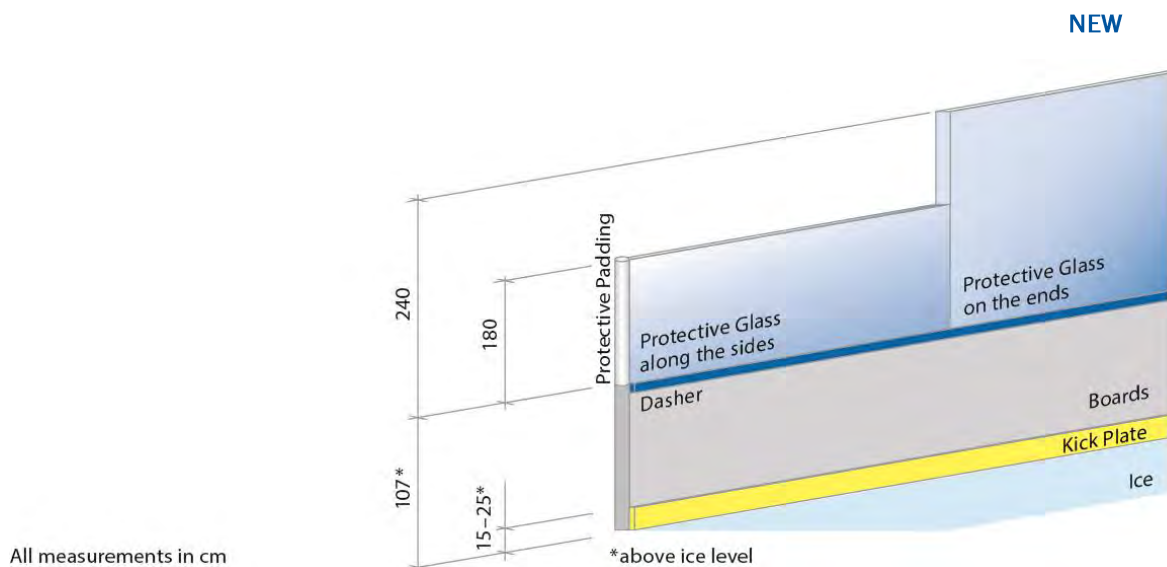

*Figure 3: Protective glass measurements. This diagram is used with the permission of IIHF.*



**207 End zone nets**

Protective nets must be suspended above the end zone boards and glass.

**208 Division and marking of the surface**

The ice surface will be divided in its length by five lines marked on the ice and extending completely across the rink and continuing vertically up the side of the boards (Figure 4).

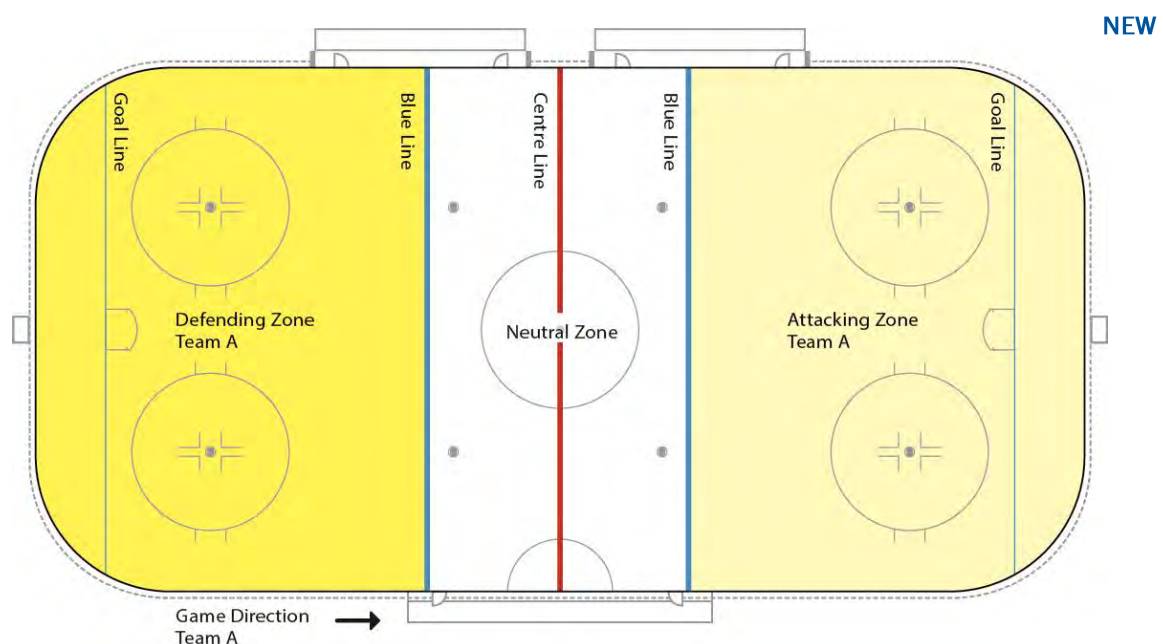

*Figure 4: Division of the playing surface. This diagram is used with the permission of IIHF.*

**209 Goal lines**

Lines shall be marked **4m** from each end of the rink, **5cm** wide and red in colour, known as the goal lines.

**210 Blue lines**

**NEW**

The blue lines must be **22.86 metres (75')** from the flat and middle sections of the end boards at both ends of the rink.

These lines will determine the three zones, defined as follows:

For one team, the zone in which their goal is situated is the **defending zone**.

The central zone is the **neutral zone**.

The farthest zone is the **attacking zone**.

### 211 Centre line

A line known as the centre line shall be located in the middle of the rink. It shall be 30cm wide and red in colour.

### 212 Face-off spots and circles

All spots and circles are marked on the ice surface in order to position the players for a face-off as ordered by the officials at the beginning of the game, at the beginning of each period and after each stoppage of play.

### 213 Centre face-off spot and circle

A circular blue spot, 30cm in diameter, shall be marked exactly in the centre of the rink. With this spot as a centre, a circle with a radius of 4.5m shall be marked with a blue line 5cm wide (Figure 5).

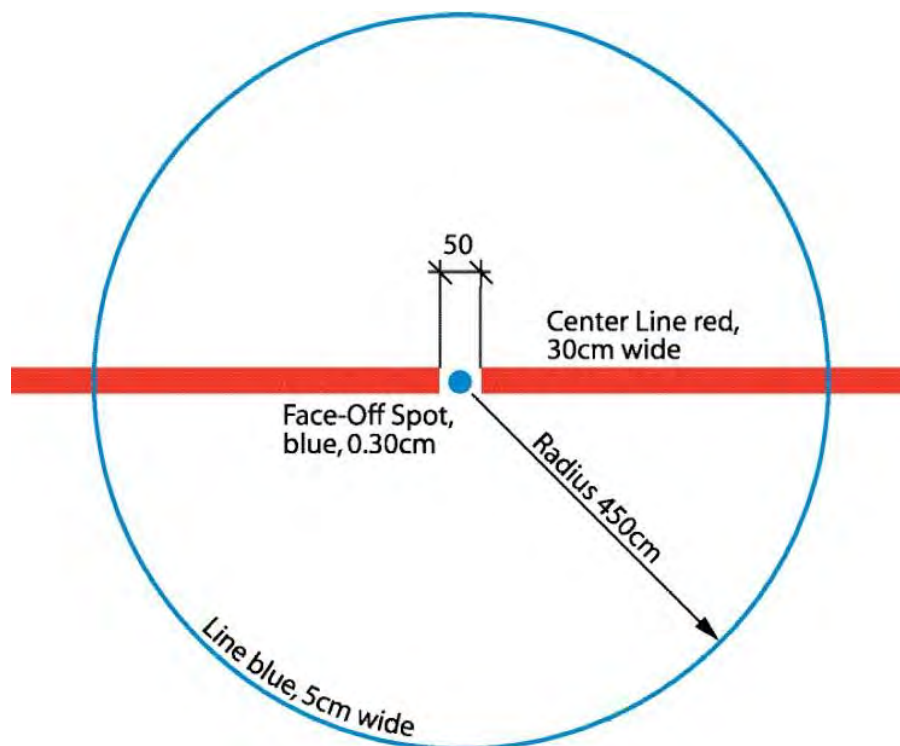

*Figure 5: Face-off circle and spot at centre of the rink. This diagram is used with the permission of IIHF.*

### 214 Face-off spots in neutral zone

Two red spots, 60cm in diameter, shall be marked in the neutral zone, 1.5m from each blue line as illustrated in Figure 6.

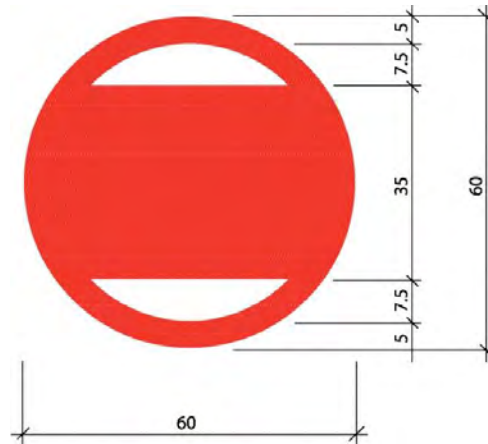

Figure 6: Face-off spot dimensions in neutral zone. This diagram is used with the permission of IIHF.

## 215 End zone face-off spots and circle

- Face-off spots and circles shall be marked on the ice in both end zones and on both sides of each goal as illustrated in Figure 7.
- The face-off spots will be 60cm in diameter, red in colour, as illustrated.
- On opposite sides of the end zone face-off spots shall be marked double 'L', as illustrated below.
- The circles will have a radius of 4.5m from the Centre of the face-off spots and marked with a red line, 5cm wide.

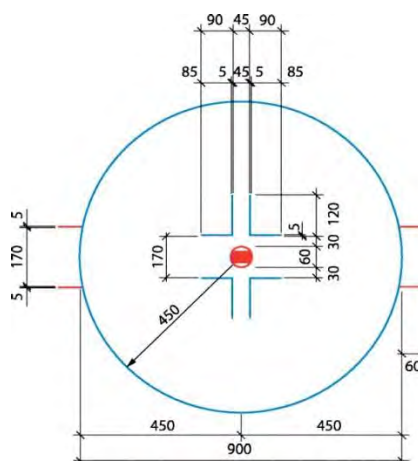
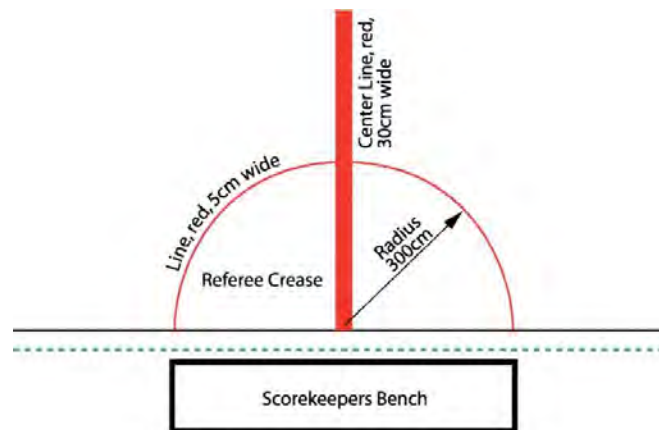

Figure 7: Face-off circle and spots at end zones. This diagram is used with the permission of IIHF.

## 216 Referee crease

An area known as the referee crease shall be marked on the ice in a semi-circle by a red line, 5cm wide, and with a radius of 3m, immediately in front of the score-keeper's bench, as illustrated in Figure 8.

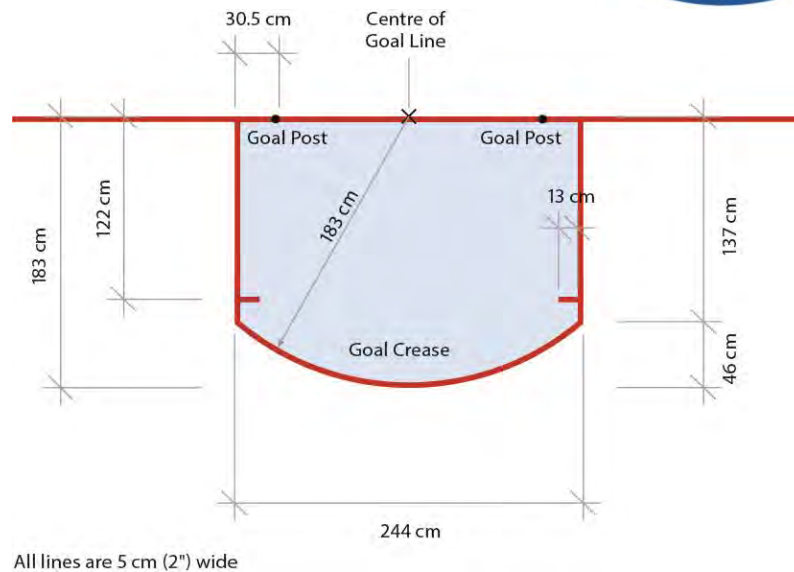

*Figure 8: The marking of the referee crease. This diagram is used with the permission of IIHF.*

## 217 Goal crease

**NEW**

- a) In front of each goal a goal crease area shall be marked by a red line, 5cm wide, as illustrated in Figure 9.
- b) The goal crease area shall be painted light blue. The inside of the goal area from the goal line to the back of the net shall be white.
- c) The goal crease area is a three dimensional space and includes the air above the markings on ice up to the top of the cross bar.
- d) The goal crease shall be laid out as follows: A 30cm (12") line outside each goal post must be painted at a right angle to the goal line, extending 137cm (4'6") towards centre ice. A semi circle of 180cm (6') in radius must be painted, using the centre ice of the goal line as the centre point and connecting both ends of the lines that form the sides of the crease.



*Figure 9: The dimensions of the goal crease. This diagram is used with the permission of IIHF.*

## 218 Goal frames, posts and netting (goal net)

- a) The goal nets shall be located in the centre of the goal lines as illustrated in Figure 10.
- b) The goal posts shall extend vertically **1.22m** above the ice surface and be **1.83m** apart (internal measurements). The goal posts and horizontal crossbar that form the tubular steel frame shall be of a specified design with an external diameter of 5cm and shall be painted red.
- c) The goals and crossbar shall be completed by a frame supporting the netting, the deepest point of which shall not be more than **1.12m** or less than **0.60m**. It shall be painted white, except for the exterior part of the base frame, which shall be painted red.
- d) A netting of white nylon cord shall be draped over to enclose the back of the goal frame in such a manner as to prevent the puck from coming to rest on the outside of it, yet strung in a manner that shall keep the puck inside the goal net.
- e) The inside of the supports, other than the goal posts and crossbar, shall be covered by a white padding. The padding of the base frame shall start not less than **10cm** from the goal posts and shall be attached in a manner that shall not restrict the puck from completely crossing the goal line.

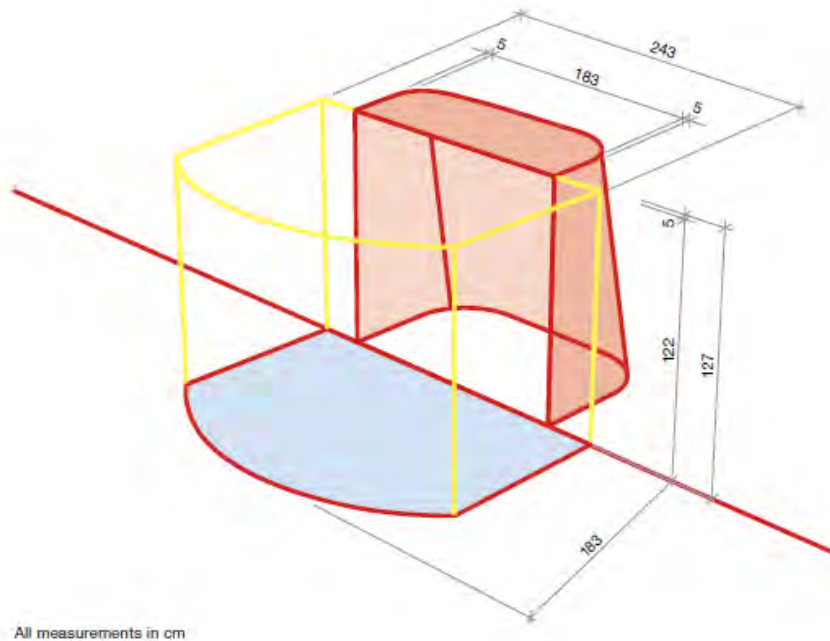

Figure 10: The positioning of the goal. This diagram is used with the permission of IIHF.

## 219 Team benches

Each rink shall be provided with two identical benches, exclusively for the use of players/goalkeepers in uniform and officials of both teams. The team benches shall be on the same side of the rink, immediately along the ice but opposite to the penalty benches, separated by a substantial distance or by other facilities, and convenient to the dressing rooms.

Each team bench shall begin **2m** from the centre line with a minimum length of **10m** and a minimum width of **1.5m**.

Each team bench shall accommodate: **15 players** in sledges and **6 team officials**.

Each team bench must have two doors, one of which must be in the neutral zone. Each team bench must be protected from access by persons other than the players and the six team officials.

## 220 Penalty benches

Each rink shall be provided with two benches to be known as the penalty benches for a minimum of **4 players** each. They shall be located on both sides of the Scorekeeper's desk and opposite to the team benches and shall have a minimum length of **4m** and a

minimum width of 1.5m. Access to the penalty benches shall be restricted to persons other than the penalized players and the penalty bench attendants.

**221 Goal judge’s bench**

Properly protected cages to eliminate interference with the goal judge’s activities shall be placed at each end of the rink behind the board and glass in the area of the goal.

**222 Scorekeeper’s bench**

Between the penalty benches will be located the scorekeeper’s bench which shall have a length of 5.5m to accommodate 6 officials.

**223 Siren**

Each rink shall be provided with a siren or other suitable sound device to be used by the timekeeper.

**224 Clock**

Each rink shall have an electric clock (scoreboard) in order to provide spectators, players and officials with accurate information (Figure 11) concerning:

- a) Names of both teams NEW
- b) Time played in any given period, counting down in minutes and seconds from 15.00 to 0.00
- c) Penalty time remaining to be served for at least two players on each team counting down from the total number of minutes to 0
- d) Score
- e) Time-outs, counting down from 60 to 0 seconds
- f) Intermission time, counting down from 15 to 0 minutes.

JAPAN		HOME	GUEST	ESTONIA	
PLAYER	PENALTY	03	03	PLAYER	PENALTY
19	— 4.27	T.O. 1	T.O. 1	06	— 3.45
11	— 1.53			22	— 1.53
04	— 2.00	20:00		30	— 5.00
17	— 1.07			17	— 0.47
20	— 0.14			20	— 0.54

*Figure 11: Electronic scoreboards with video text are recommended for WPIH Competitions and Sanctioned Competitions.*

## **226 Red and green lights**

Behind each goal there shall be a red light to be lit by the goal judge when a goal is scored, and a green light to be lit automatically by the electric clock when the timekeeper stops the clock at the end of each period.

- a) The red light shall be connected to the timing device in such a manner so that, when the period has ended, it would be impossible for the goal judge to turn it on.
- b) At the end of a period, the fact that the goal judge is not be able to turn on the red light on does not necessarily mean that a goal is not valid. The determining factor is whether or not the puck is completely over the goal line and in the goal before the period ends.
- c) The purpose of the green light is to enable the Referee and Linesmen to observe the goal and light in the same sight line and know exactly when the period ends.

## **229 Rink lighting**

All rinks shall be sufficiently well illuminated in accordance with the standards stipulated in the technical requirements for the specified/respective competition:

- a) If there is not sufficient light to continue the game, the Referee shall have the authority to postpone or cancel the remainder of the game, or take a time-out, pending improvement of the lighting situation.
- b) If one team is disadvantaged to a greater extent by the failure of lights, and in the opinion of the Referee in consultation with the technical delegate, the game should not be cancelled; the teams will alternate ends of the rink and play the same amount of time in each end of the rink.
- c) If in the opinion of the Referee in consultation with the technical delegate the failure of lighting does not result in a greater disadvantage to one team, play will resume.



### 3 Player equipment, clothing and protective equipment NEW

World Para Ice Hockey may conduct equipment checks at Recognised Competitions at any time throughout the competition including, but not limited to pre-competition training to ensure equipment adheres to these Rules. All equipment shall be approved by the Technical Delegate or designated person nominated by WPIH (e.g. equipment controller) during the scheduled equipment check prior to the start of each Recognised Competition. Equipment must not be altered after it has been approved or marked by the TD/WPIH designated person at the equipment check and uninspected equipment must not be used.

All protective equipment, clothing, accessories and footwear must meet generally accepted standards for ice hockey and must be from a recognised ice hockey manufacturer. It is the responsibility of the player to ensure that the equipment used conforms to the official playing rules.

All equipment used by the athletes must be in compliance with the [IPC Sport Equipment Policy](#), these Rules and the World Para Ice Hockey Uniform and Advertising Guidelines. World Para Ice Hockey adheres to HECC (Hockey Equipment Certification Council) as the governing body on the approval of all ice hockey helmets and facial protection, for players and goalkeepers. For any current and updated lists refer to the HECC web site: <http://www.hecc.net/>.

All infractions related to the equipment shall be dealt with under Rule 1045 and/or Regulation 11.

Equipment will be measured in accordance with the Measurement Tools and Standards as outlined in Appendix 1.

#### **Player equipment (mobility devices)**

Player equipment shall be defined as the sledge, sticks and picks. The sledge consists of a frame, heel/leg support, front skid, foot guard, bucket (sledge seat), blade carrier and blades as outlined in Figure 12.

Sledge:

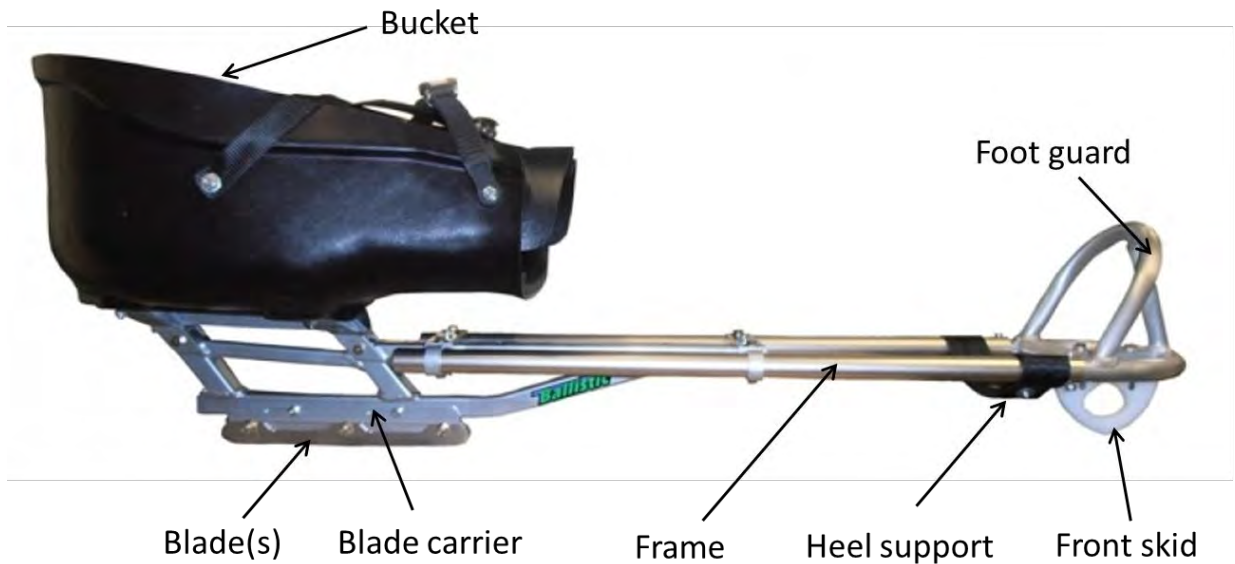

Figure 12: Sledge and its constituents. This diagram is used with the permission of Unique Inventions Inc.

### 300 Sledge frames

a) Sledge frames may only be constructed from the following approved material(s): steel, aluminium, titanium and magnesium. The material must not have a diameter smaller than 1.5cm or greater than 3cm.

b) The frame's main side rails shall be 15cm minimum width (measured from the outside of the frame) and a maximum width no greater than the seat of the sledge. The side rails of the frame may taper underneath the seat to accommodate the blades; any taper must not exceed 45 degrees (Figure 13). No more than 1cm of the frame may protrude beyond the rear of the bucket (Figure 14).

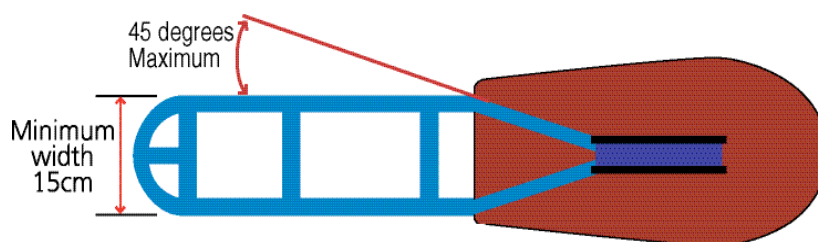

Figure 13: Sledge frame dimensions

The blade carrier may sit on the rear end of the frame however the frame must protrude 1cm beyond the end of the blade.

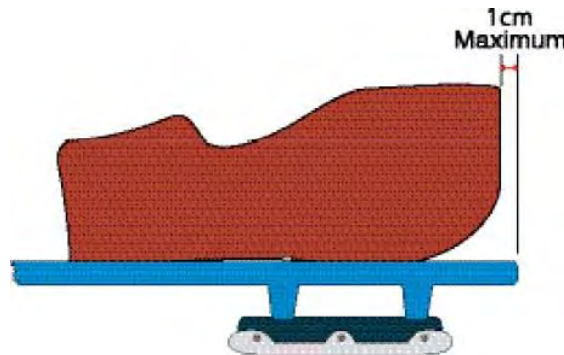

Figure 14: Sledge frame must not protrude more than 1cm beyond the rear of the bucket

c) The front of the sledge shall have a continuous curve with a maximum radius one half of the inside width of the frame at its widest point forward of the bucket (Figure 15).

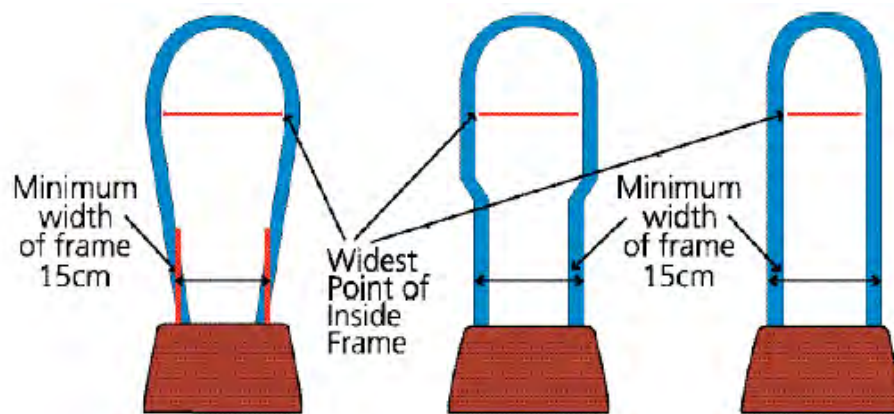
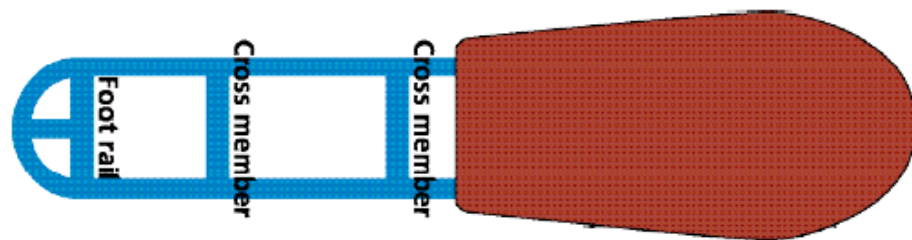

Figure 15: The radius of the front of the sledge

d) The frame may be fitted with a minimum of **one** cross member and a maximum of **four** (except for players with a double amputation\* where the sledges may be fitted with maximum of **two** cross members), and one foot rail, mounted forward of the bucket. The cross members may be square (minimum dimensions of 1.33cm x 1.33cm and maximum

2.66 x 2.66cm) or cylindrical (minimum diameter 1.5cm and maximum diameter 3cm) (Figure 16).



*Figure 16: Number of cross members and their placement*

\*Players with a double amputation in these Rules are defined per WPIH Classification Rules and Regulations.

e) The height of the main frame measured from the ice to the bottom of the frame shall be 8.5cm minimum to 9.5cm maximum.

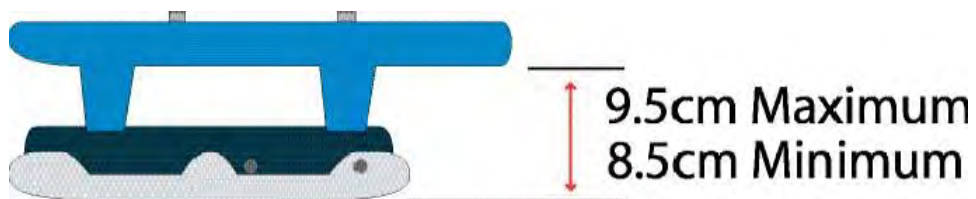

*Figure 17: Minimum and maximum height of the frame*

f) Buckets may sit on the blades/blade carrier. The seat (bucket) may not sit lower than the frame.

g) For all sledges the minimum length of the frame must be 80cm.

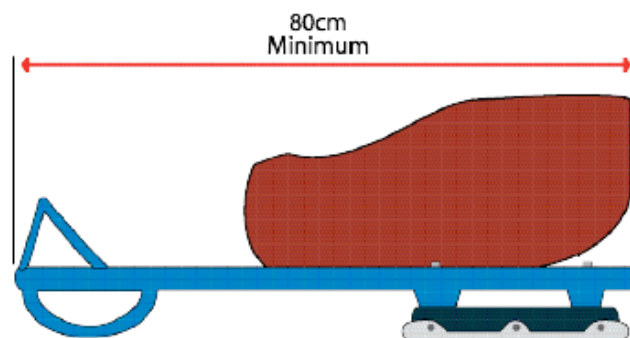

Figure 18: Minimum length of the sledge

- h) Any attachments to the frame are not allowed unless they are approved by WPIH.
- i) Sledge frames including its attachments must not have any sharp edges.

### 301 Heel support/leg support

Each sledge may have a heel support with a maximum width of **10cm**. For a player with single amputation a second support called the leg support may be used for the residual limb (maximum width of **10cm**) (Figure 19). No part of the residual limb may protrude beyond the frame. The clearance between the ice and the loaded heel/leg support must be **3cm** minimum.

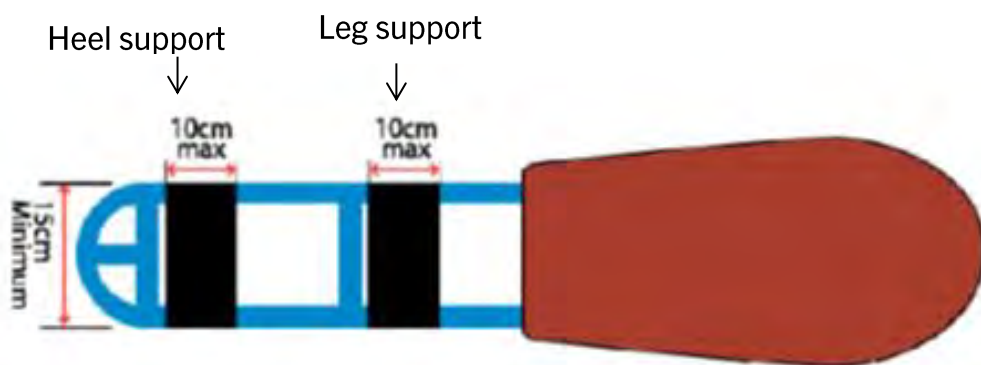

Figure 19: Heel/leg support maximum width

### 302 Front skid

The sledge must have **one** skid. The front skid must be attached to the frame not more than **3cm** from the front of the main frame. The skid must be mounted in the centre of the frame and extend backwards **10cm** minimum and **20cm** maximum. The skid measured from the frame downward towards the ice must be no less than **7cm** and no greater than **9.5cm**.

- a) The skid may be made of the same material as the main frame. If made of the same material, it must be cylindrical and have a diameter of not less than **1.5cm** and not more than **3cm**.

b) The skid may be designed of a nylon/plastic material. The shape must not be square nor have straight edges. It may be solid in shape and have a width of not less than 1.5cm and not more than 3cm.

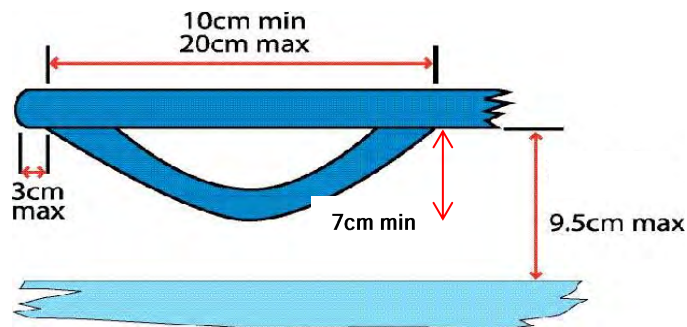

Skids cannot be designed in the following styles:



Figure 20: Dimensions of the skid and illegal shapes of the skid

### 303 Foot guard

A foot guard is required for all players, regardless of the impairment. The tubes of the foot guard shall be made from the same material as the main frame with a diameter of not less than 1.5cm and not more than 3cm.

a) The foot guard shall be the standard manufactured height of no less than 16cm to allow for suitable protection. The height of the foot guard for players with double amputation of lower limbs shall be no less than 7.5cm for safety reasons. Refer to Rule 304.

b) The foot guard must not extend outside the main frame and must not extend above the players feet/foot/residual limb. Refer to Rule 304.

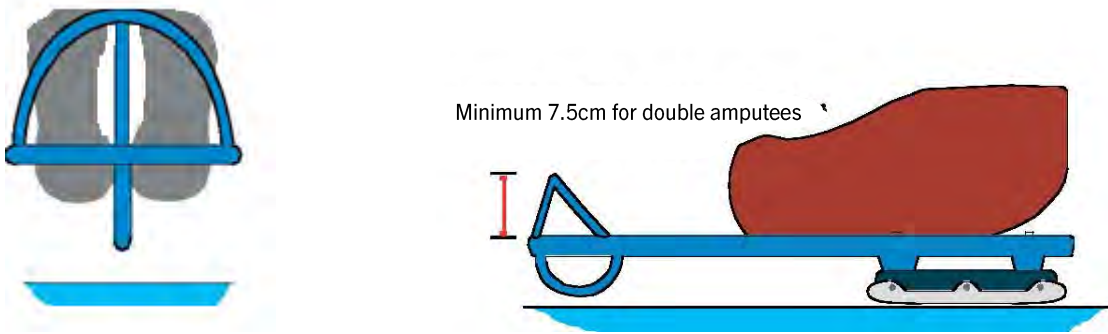

Figure 21: The foot guard must be high enough to protect the player's feet. For players with double amputation of lower limbs the height of the foot guard must not be lower than 7.5cm.

### 304 Foot and residual limb protection

All players, including goalkeepers, must wear ice hockey skate boots as protection for the foot and ankle area. Medical exceptions are possible with prior written approval from WPIH. If a medical exception is granted, the foot guard must be the same height as the player's feet and a hard protective shell must be built into the frame to protect the player's feet. Any request for a medical exception must be submitted to WPIH in writing no later than three months prior to start of the competition.

Players with residual limbs must have their residual limbs protected with a hard protective shell.

### 305 Blades/blade carrier

Each sledge shall be mounted with **two** blades maximum. If the sledge consists of two blades, then the blades must be mounted parallel and square under the bucket of the sledge. There is no minimum width requirement between the two blades but they must not be mounted wider than the width of the bucket. Each blade must be minimum **16cm** in length but no longer than **32cm**. The blade(s) must not protrude more than **1cm** beyond the front or back of the blade carrier. See Figure 22. The blade(s) must not be made of plastic (except for goalkeepers).

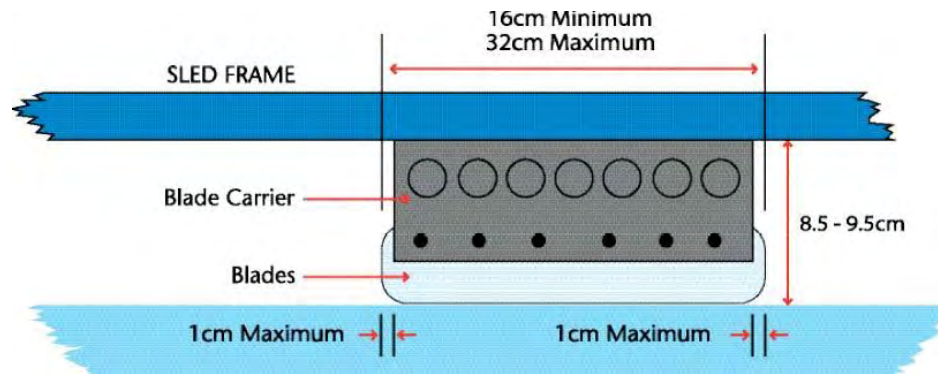

Figure 22: Blade and blade carrier

### 306 Bucket

a) The bucket may be made from any suitable material and must have no sharp edges (edges must be rounded off). No more than 1cm of the frame may protrude beyond the rear of the bucket.

b) The maximum height a bucket may sit above the ice is 20cm, measured from a flat surface to the lowest point of the underside of the main seating area of the bucket (Figure 23).

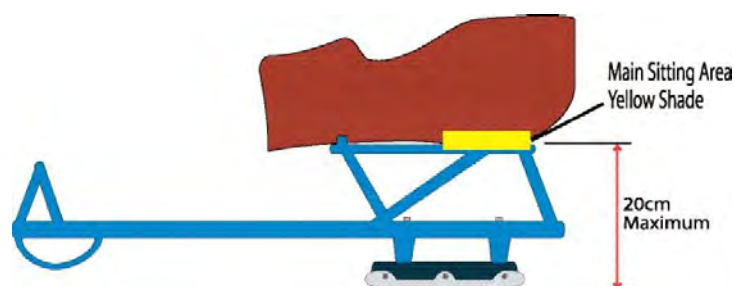

Figure 23: Sledge height

c) Removable seat cushions or built-in padding or a combination thereof must not exceed 5cm in height, nor overlap the bucket.



- d) No external projection or protuberance of more than **1cm** beyond the bucket or beyond the back support towards the rear of the sledge is permitted.
- e) Straps and/or adhesive tape and/or a protective shell may be used to secure players' feet, ankles, knees and hips to the sledge. These must not extend outside or below the main frame.

### 307 Hockey sticks

Sticks may be made of wood or other material, such as carbon fibre and fiberglass. They must not have any projections and all edges must be bevelled. Nothing shall be added to the sticks apart from picks and tape.

Adhesive non-fluorescent tape of any colour may be wrapped around the stick at any place. Only tape that is rolled onto a stick is allowed for covering the blade. Any adhesive, peel-and-stick tape is not permitted.

The end of the sticks must be closed either with tape or plugs.

The dimensions of the sticks are (see Figure 24):

Stick:

- Maximum length – **100cm** from the toe to the pick end of the shaft

Blade:

- Maximum length - **32cm** from the heel to the toe
- Maximum width - **7.5cm**

The player's stick blade may be curved, and the curvature shall be restricted in such a way that the distance of a perpendicular line, measured from a straight line drawn from any point at the heel to the end of the blade, shall not exceed **1.5cm**. The heel of the stick blade is the point when the blade curves upwards when positioned on a flat surface with a blade pointing upwards.

Anytime a stick measurement is requested by a team or conducted by the Referee/designated official, both player's sticks shall be measured.

The curvature of a stick will be measured either by using an approved stick gauge or other approved method (See Appendix 1).

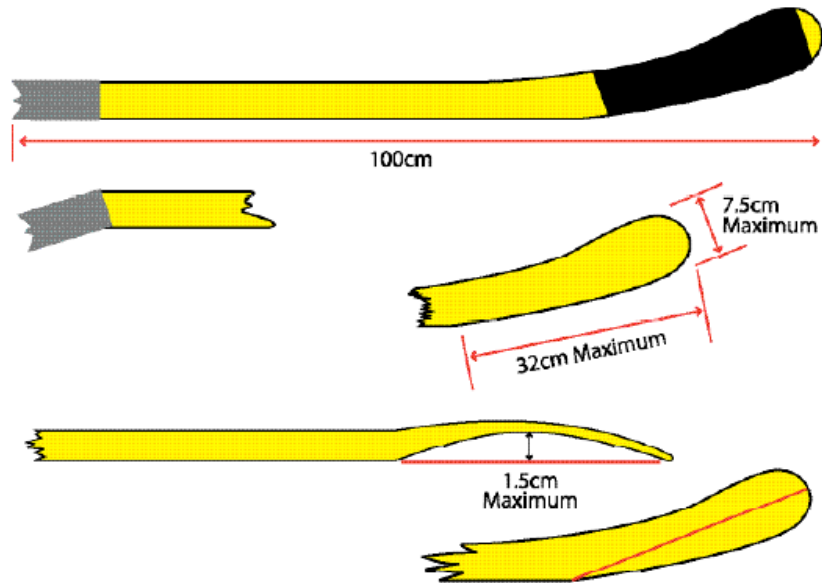

Figure 24: Dimensions of the sticks

### 308 Picks

The depth of the teeth on the pick-ends shall not extend **4mm**. The pick-ends must be fixed to the lower or butt end of the stick and not end in a single sharp point but have at least **6** teeth of equal length per stick (minimum **3** each side) to avoid damaging the ice surface.

Each tooth on a pick shall not be conical or come to a sharp needle-like or piercing point to avoid puncturing type wounds or possible slashes, intentional or accidental. The pick ends may be made of any strong material including steel and must not be longer than **10.2cm**. The pick-ends shall not extend at any angle beyond **1cm** of the end of the solid portion of the stick. The pick end may be bevelled. The minimum thickness is **3.2cm** (Figure 25).

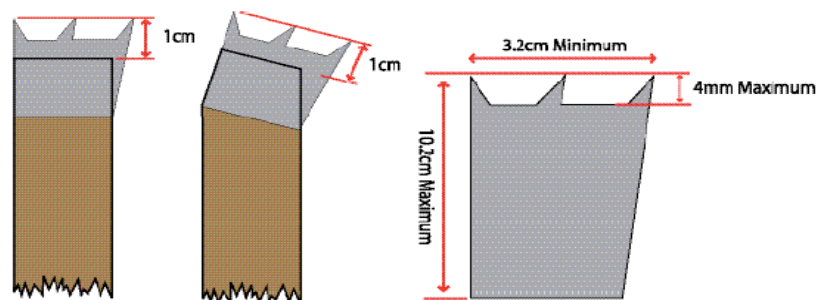

Figure 25: Dimensions of the picks

## **Player protective equipment**

Protective equipment for players shall be defined as:

Helmet; full facemask; gloves; throat protector; mouth guard; shin protection; elbow pads; and shoulder pads.

### **310 Helmet**

During the pre-game warm-up and during the game, all players must wear a hockey helmet that is **HECC** approved with chin strap properly fastened. A helmet shall be worn so that the lower edge of the helmet is not more than one finger width above the eyebrows, and there must only be enough space between the strap and the chin to insert one finger. Illegible or missing HECC labels and helmets with HECC expired certification labels render the helmet uncertified.

### **311 Full face mask**

During the pre-game warm-up and during the game, all players must wear a full face mask that is approved by **HECC**. The full face masks must be constructed in such a way that neither the puck nor a stick blade and the pick end of the stick might get through it.

Coloured or tinted full face masks and visors are not permitted.

### **312 Gloves**

During the pre-game warm-up and during the game, all players must wear ice hockey gloves that cover hands and wrists. The palm must not be removed to permit the use of bare hands. All players must wear ice hockey player's gloves.

### **313 Throat protector**

During the pre-game warm-up and during the game, all players must wear a neck/throat protector. The throat protector cannot be modified in any way.

### **314 Mouth guard**

During the pre-game warm-up and during the game, it is recommended that all players wear a custom designed mouth guard.

### **315 Shin protection**

During the pre-game warm-up and during the game, all players must wear shin protection covering the area between the ankles and knees considering their impairment.

### **316 Elbow pads**

During the pre-game warm-up and during the game, all players must wear elbow protection covering the back of the elbow joints.

### **317 Shoulder pads**

During the pre-game warm-up and during game, all players must wear shoulder protection covering the shoulder and upper arm areas between the elbow and shoulder joints.

## **Goalkeeper equipment and protective equipment**

Goalkeeper equipment shall be defined as the sledge, sticks and picks. The sledge consists of a frame, heel/leg support, front skid, foot guard, bucket (sledge seat), blade carrier and blades

### **318 Goalkeeper's sledge**

Sledges for goalkeepers must meet the specifications and requirements set out in Rules 300 a-f, 300 h-i, 301, 302, 303, 304, 305, 306, 308 above with the following variations:

- If the goalkeeper sits cross-legged, the bucket may be extended sideways to protect the knees but may not protrude more than **1cm** beyond the player's knees.

### **319 Goalkeeper's sticks**

Sticks shall be made of wood or other similar material, such as carbon fibre and fiberglass. They must not have any projections and all edges must be bevelled. Adhesive non-fluorescent tape of any colour may be wrapped around the stick at any place. Only tape that is rolled onto a stick is allowed for covering the blade. Any adhesive, peel-and-stick tape is not permitted. The butt-end of sticks cannot be taped black.

Dimensions (see Figure 26):

- Shaft:
  - Maximum length – **100cm** measured along the centre line

- Minimum width – 2cm
- Minimum thickness – 2.8cm
- Blade:
  - Minimum length – 30cm
  - Maximum length – 39cm from the heel to the toe
  - Maximum width – 9cm

The goalkeeper’s stick blade may be curved, and the curvature shall be restricted in such a way that the distance of a perpendicular line, measured from a straight line drawn from any point at the heel to the end of the blade, shall not exceed 1.5cm. The heel of the stick blade is the point when the blade curves upwards when positioned on a flat surface with a blade pointing upwards.

The goalkeeper’s stick may have an additional pick at the heel of the blade.

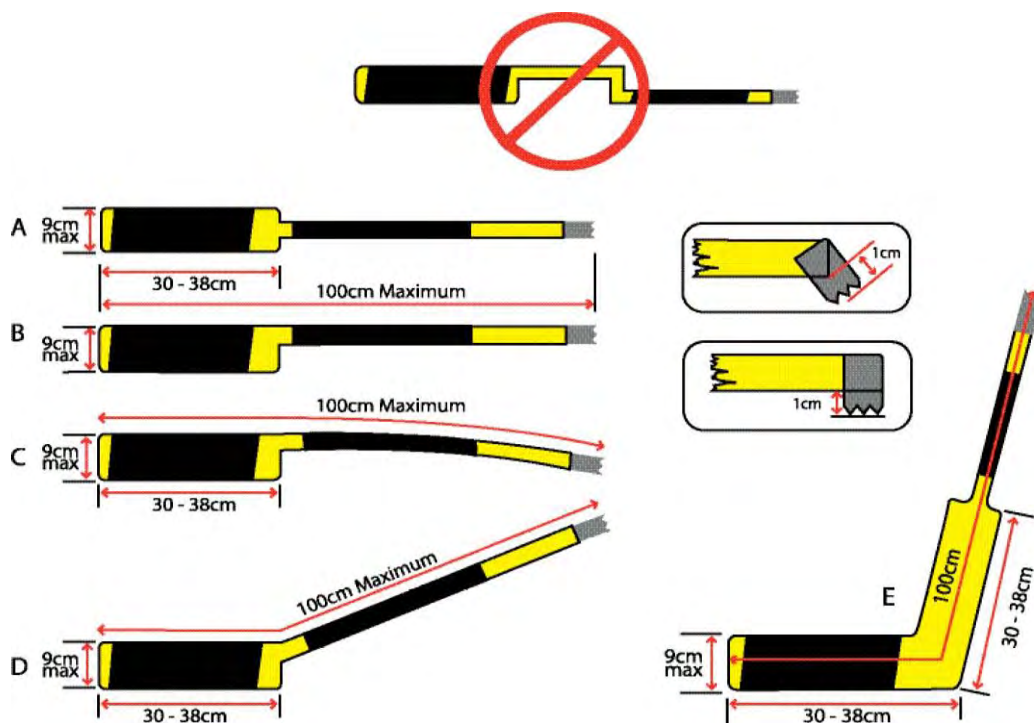

Figure 26: Goalkeeper sticks

### 320 Goalkeeper's protective equipment

Rules 310, 311, 314, 315, 316, 317 apply with the additions below.

### 321 Catching glove

During the pre-game warm-up and during the game, goalkeepers must wear a catching glove that covers hand and wrist. The palm must not be removed to permit the use of bare hands. The maximum outside dimensions of the catching glove shall not exceed: **20.32cm** in length at any part of the wrist cuff, which shall be **10.16cm** in width (height). Distance from the heel along the pocket to the top of the T trap shall be no more than **46cm**. The perimeter of the catching glove shall not exceed **114.3cm** (see Figure 27).

Picks are permitted but must be securely attached to the catching glove. The picks shall not exceed **1cm** in length.

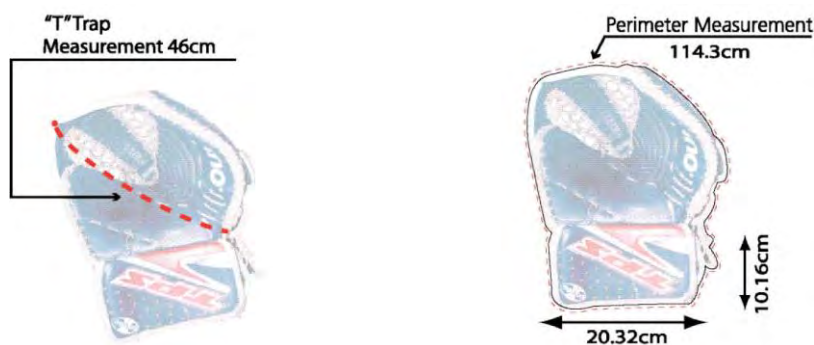
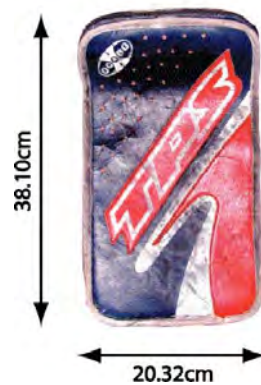

Figure 27: Goalkeeper catching glove

### 322 Blocking glove

During the pre-game warm-up and during the game, goalkeepers must wear a blocking glove that covers hand and wrist. The palm must not be removed to permit the use of bare hands. The maximum dimensions of the protective padding attached to the back of the forming part of a blocking glove, shall measure (see Figure 28):

- **38.1cm** in length
- **20.32cm** in width



*Figure 28: Goalkeeper's blocking glove*

No picks are permitted on the blocking gloves.

### **323 Goalkeeper's helmet and full face mask**

- a) During the pre-game warm-up and during the game, all goalkeepers on the ice must wear a HECC approved ice hockey goalkeepers helmet or HECC approved ice hockey player's helmet with a facemask. Backup goalkeepers are not required to wear a helmet while on the bench.
- b) Goalkeeper's face masks must be constructed in such a way that a puck or any part of a stick may not get through it. Cat-eye wire masks are not permitted.
- c) Graffiti-type designs, patterns, artwork, drawings, or slogans that are abusive or obscene and refer to culture, race, or religion are not permitted.



*Figure 29: Goalkeeper's helmet and full face mask*

### 324 Goalkeeper's leg guards or pads

- a) Goalkeepers must wear leg protection. A goalkeeper may use ice hockey shin guards or goalie pads. One shin guard or goalie pad is permitted per leg. Goalkeepers with residual limbs must have their residual limbs protected.
- b) The goalkeeper's pad or shin guard must not exceed **5cm** higher than any part of the leg(s) of the goalkeeper and must not extend beyond the feet.
- c) The width of the goalkeeper's pads or shin guards must not exceed **28cm** in width when measured on the leg of the goalkeeper. Goalkeepers sitting horizontally must not have goalkeeper pads or shin guards extending sideways beyond the frame further than **5cm**. Goalkeepers sitting cross-legged must have goalkeeper pads or shin guards contour the knee and that do not protrude more than **5cm** outside the frame.
- d) No straps or any part of the goalkeeper's pad/shin guard/feet/any other material may hang more than **2.5cm** below the frame. The area below the frame must be cleared for the puck to pass under.
- e) A plate or any kind of device covering the space between the sledge frame and the ice is not permitted.
- d) The maximum length of the goalkeeper's leg pads is **96.52cm** from bottom mid-point to top mid-point of the pad.
- f) The minimum length of the boot of the pad must be no less than **17.78cm**. The boot is the bottom of the pad that sits over the top of the skate. The boot channel of the goalkeeper's pad must be flat or concave in appearance.
- g) No attachments such as plastic puck foils are permitted.
- h) No raised ridges to deflect the puck will be permitted on the goalkeeper's pads/shin guards.
- i) Graffiti-type designs, patterns, artwork, drawings, or slogans that are abusive or obscene and refer to culture, race, or religion are not permitted. The pads/shin guards may be any non-fluorescent colour(s).

### 325 Goalkeeper neck and throat protector

All goalkeepers must wear a neck and throat protector. No modifications are allowed for neck and throat protectors.



## 4 Player clothing NEW

### 400 Uniforms

All players and goalkeepers from each team shall be dressed uniformly in matching jerseys, pants, socks and helmets (except for the goalkeeper(s) who is permitted to wear a helmet of a different colour to the rest of the team). For Paralympic Winter Games the uniforms must comply with the IPC Manufacturer Identification Guidelines. For IPC Competitions and WPIH Sanctioned Competitions the uniforms must comply with the World Para Ice Hockey Advertising Guidelines.

For all Recognised Competitions each participating team must have two sets of jerseys and socks, one of light colour and one of dark colour. Both sets must be approved in writing by WPIH. The home team will have the choice of jersey colour.

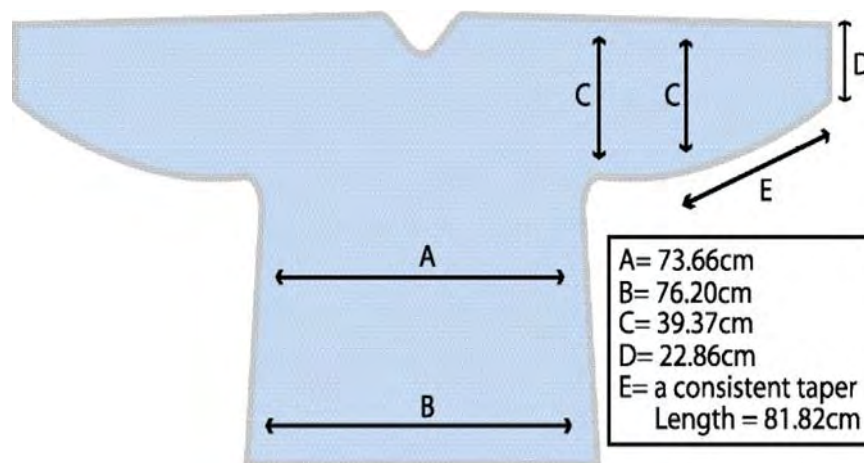

Figure 30: Jersey

- a) The basic colour must cover approximately 80 percent of each part of the equipment, excluding names and numbers.
- b) Jerseys, including the sleeves and socks shall be of the same colour.
- c) Jerseys shall be worn so that no part of hangs below the sledge frame.
- d) Each player shall wear an individual number 25 to 30cm in height, centred on the back of the jersey and 10cm in height on both shoulders. Numbers are limited to 1 to 99.

- e) The captain must wear the letter 'C' and alternate captains must wear the letter 'A', 8cm in height and in a contrasting colour, in an obvious position on the front of the jersey.
- f) Each player shall wear his/her name centred on the upper portion of the back of his/her jersey, printed 8cm in height, in block capital Roman letters.
- g) Graffiti-type designs, patterns, artwork, drawings, or slogans that are abusive or obscene and refer to culture, race, or religion are not permitted on any part of the uniform.
- h) Any team, player and/or goalkeeper that does not comply with these Rules shall not be permitted to participate in the game.
- i) If, in the opinion of the Referee, the uniform colours of any competing teams are so similar that there is the possibility of miscalling a penalty, it is the responsibility of the home team to change their jerseys, if ordered to do so by the Referee.
- j) If a player's hair is long and if worn out would obscure the nameplate or number on the jersey, it must be worn in a ponytail or under the helmet.
- k) Each team must have replacement jerseys (light and dark) available for all players in case a player's jersey becomes unwearable.
- l) Before each game, the manager or coach of each team shall provide the Referee or Scorekeeper with a list of names and numbers of eligible players, including the names of the captain and alternate captains. All players shall have the same number on their respective dark and light jerseys.

## 5 Competition equipment

### 501 Puck

The puck shall be made of vulcanized rubber and be primarily black in colour. The puck shall be approved by WPIH regarding any logo, trademark and/or advertising placement for Recognised Competitions.

The dimensions of a puck shall not exceed:

- Diameter - **7.62cm**
- Thickness - **2.54cm**
- Weight - **156 to 170gms**

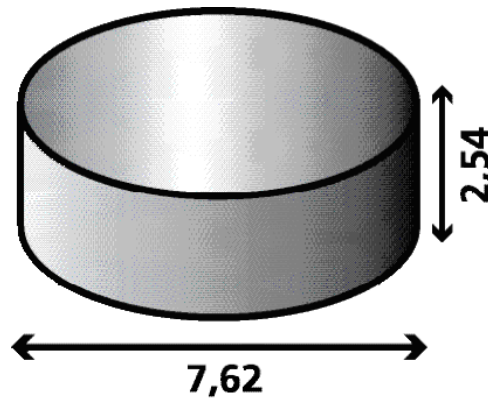

Figure 31: Dimensions of the puck.

## 6 Game format

### 600 Timing of game

The regular game shall consist of three (15) minute actual time periods and two (15) minute intermissions. The teams shall change ends for each period.

### 601 Start of game and periods

A game or period shall begin with a face-off at the centre face-off spot. The teams shall start a game defending the goal nearest to their team bench.

Teams shall change ends for each succeeding period (regular or overtime). Teams shall not change ends when the ice has not been resurfaced for an overtime period or Penalty Shot Shootout.

a) Playing time shall commence from the instant the puck is faced-off and shall stop when the whistle is blown.

b) If any unusual delay occurs within five minutes of the end of the first and second period, the Referee may order the next regular intermission to be taken immediately. When play resumes, the remaining time shall be played with the teams defending the same goal as before the intermission, after which time the teams change ends and resume playing the ensuing period without delay.

c) During the intermissions the ice shall be resurfaced.

- d) All players must leave the ice during the resurfacing and not return until ordered to do so by the Referee.
- e) If the teams are unable to leave the ice surface, the Referee will designate an area of the ice for each team to rest while the ice is being resurfaced.

## **602 Time out**

- a) Each team shall be permitted one (1) minute time-out during the course of regular time or during overtime.
- b) During a normal stoppage of play, any player designated by the Coach may ask the Referee for the time-out. The Referee shall report the time out to the scorekeeper.
- c) The players and goalkeepers of both teams, except for penalized players, are allowed to go to their respective team benches.
- d) Each team may take their time-out at the same stoppage of play, but the team taking the second time-out shall notify the Referee before the end of the first time-out.

## **603 Determining the outcome of the game**

- a) The team scoring the greatest number of goals during the three (15) minute periods shall be declared the winner.
- b) If, at the end of the game, the score for both teams is equal, the game shall be prolonged by a 'Sudden Victory' overtime period (see Rule 604).
- c) If no goal is scored in the 'Sudden Victory' overtime period, 'Penalty Shot Shootout' shall apply (see Rule 605).

## **604 Overtime period**

If in a preliminary round game, the game is tied at the end of regulation time, a five-minute overtime period shall be played immediately after an intermission of three minutes. The teams will defend the same goals as in the third period. The game will end when the five minutes has expired or when a goal is scored; the scoring team will be declared the winner. If no goal is scored in the overtime period then the Penalty Shot Shootout Procedure will apply.

If a playoff game, a semi-final game or a bronze medal game is tied at the end of regulation time, then a ten-minute overtime period shall be played immediately following the completion of an intermission of three minutes. The teams will defend the same goals as in the third period. The game will end when the ten minutes has expired or when a

goal is scored; the scoring team will be declared the winner. If no goal is scored in the overtime period then the Penalty Shot Shootout Procedure will apply.

If a Gold Medal Final Game is tied at the end of regulation time, then a fifteen-minute overtime period shall be played immediately following the completion of a 15-minute intermission during which the ice will be resurfaced. The teams will change ends for the overtime period. The puck will be faced off at centre ice. The game will end when the fifteen minutes has expired or when a goal is scored; the scoring team will be declared the winner. If no goal is scored in the overtime period then the Penalty Shot Shootout Procedure will apply.

All overtime periods shall be played with each team at the numerical strength of four (4) skaters and one (1) goalkeeper. Specific rules for this procedure are as follows:

- 1) If a team is penalized in overtime, the teams will play 4-on-3. Coincidental penalties do not affect the on-ice strength when assessed in overtime.
- 2) In overtime, if a team is penalized such that a two-man advantage is called for, then the offending team will remain at three (3) skaters while the non-offending team will be permitted a fifth skater.
- 3) At the first stoppage of play after the two-man advantage is no longer in effect, the numerical strength of the team will revert back to either a 4-on-4 or a 4-on-3 situation, as appropriate.
- 4) If there is a manpower advantage situation, which carries over from regulation time to overtime, the above criteria will be applied at the start of the overtime. Accordingly, if at the end of the regulation time, the teams are 5-on-4, overtime begins at 4-on-3.
- 5) When the regulation time ends with on-ice manpower strength of 5-on-3, teams will commence the overtime with strength of 5-on-3. With the expiration of penalties, due to continuous action, player strength may get to 5-on-5 or 5-on-4. At the first stoppage of play following, player strength must be adjusted to 4-on-4 or 4-on-3.
- 6) If at the end of regulation time teams are 3-on-3, overtime starts 3-on-3. Once player strength reaches 5-on-4 or 5-on-5, at the next stoppage player strength is adjusted to 4-on-3 or 4-on-4, as appropriate.
- 7) If at the end of regulation time teams are 4-on-4 with a player or players in the box, overtime starts 4-on-4 and players exit the penalty box as normal to 5-on-4 or 5-on-5. At the first stoppage of play, teams are adjusted to 4-on-3 or 4-on-4, as appropriate.

**NEW**

## 605 Penalty shot shootout procedure

If no goal is scored in the overtime period then the Penalty Shot Shootout Procedure applies. The following procedure will be utilized:

- 1) The teams will not change ends for the Penalty Shot Shootout Procedure. The centre section of the rink will be dry scraped by the ice-resurfacing machine prior to the Penalty Shot Shootout during the time required to organize the program accordingly. The home team shall have the choice of shooting first or second.
- 2) The procedure will begin with three different shooters from each team taking alternate shots. The players do not need to be named beforehand. Eligible to participate in the Penalty Shot Shootout will be all players from both teams listed on the official game sheet except as specified in article 3 below.
- 3) All players are eligible to participate in the Penalty Shot Shootout Procedure unless they are serving a Misconduct Penalty or have been assessed a Game Misconduct or Match penalty.
- 4) The Referee will call the two Captains to the Referee crease. The home team will have the choice whether his team will shoot first or second.
- 5) Once the Penalty Shot Shootout Procedure begins, the goalkeeper cannot be replaced unless he/she is injured. No warm up shall be permitted for a substitute goalie.
- 6) The shots will be taken in accordance with rule 1008.
- 7) The players of both teams will take the shots alternately until a decisive goal is scored. The remaining shots will not be taken.
- 8) If the result is still tied after 3 shots by each team the procedure shall continue with a tie-break shoot-out by one player of each team, with the same or new players, with the other team starting to take the tie-break shots. The same player can also be used for each shot by a team in the tie-break shoot-out. The game shall be finished as soon as a duel of two players brings the decisive result.
- 9) The official score-keeper will record all shots taken, indicating the players, goalkeepers and goals scored.
- 10) Only the decisive goal will count in the result of the game. It shall be credited to the player who scored and to the goalkeeper concerned.

11) If a team declines to participate in the Penalty Shot Shootout Procedure the game will be declared as a loss for that team and the other team will be awarded 3 points for a win. If a player declines to take a shot it will be declared 'no score' for his team.

## 7 Teams

### 700 Team composition

NEW

For a game, each team may comprise maximum of **thirteen (13)** players and **two (2)** goalkeepers, for total of **fifteen (15)** eligible athletes wearing the designated team uniform unless a team includes one or more female athletes in which case the team may comprise maximum of **fourteen (14)** players and **two (2)** goalkeepers. The names, number assignments and other required information for officiating the competition must be provided by each team prior to a game in accordance with the World Para Ice Hockey Regulations. No changes or additions shall be permitted to the list once the game has started. Every team must have at least **one (1)** staff member behind the bench to act as coach and at least **one (1)** qualified trainer or medical expert to treat players in case of injury.

### 701 Team Captain

Each team must appoint a Captain and no more than **two (2)** Alternate Captains from the **thirteen (13)** players. The Captain shall have the privilege to discuss with the Referee only matters relating to the interpretation of the rules that may arise during the course of the game. A complaint on a given penalty is not considered a matter relating to the interpretation of the rules. If a Captain or Alternate Captain is not on the ice, they cannot come off the team bench unless invited by the Referee. If both the Captain and Alternate Captain are on the ice, only the Captain has the privilege of conversing with the Referee. Players that do not wear a 'C' or 'A' on their jersey will not be granted the privileges of conversing with the Referee.

### 702 Athletes on the ice

A team shall not have more than six athletes on the ice at any time while play is in progress. Each team shall be allowed to have a maximum of one goalkeeper on the ice while play is in progress. A goalkeeper may be substituted by a player. In such case, any player on the ice shall not be permitted the privileges of the goalkeeper. The six athlete positions are:

Goalkeeper

Right Defensive Player    Left Defensive Player

Right Wing Player    Center Player    Left Wing Player

### **703 Substitution of players and goalkeepers**

- a) Players and goalkeepers may be substituted at any time during play or stoppage time
- b) If, during a substitution, either the player/goalkeeper entering the ice or the player/goalkeeper leaving the ice plays the puck or intentionally makes physical contact with an opposing player/goalkeeper while the retiring player/goalkeeper is actually on the ice, the Referee shall assess a:
  - **Bench Minor** penalty (see Rule 1063)
- c) If, during the substitution, the puck strikes either the entering player/goalkeeper or retiring player/goalkeeper accidentally, the play will not be stopped and no penalty shall be assessed
- d) No warm-up shall be allowed to any player or goalkeeper at the end of the first and second period, or during any stoppage of play
- e) In the application of the rule, the change of one or more players shall constitute a line change.

### **704 Change of players and goalkeepers from the team bench during play**

- a) The players and goalkeepers may be changed at any time from the team bench while the game is in progress provided that:
  - The changing of players and goalkeepers within an area limited by the length of the respective team bench and **3m** from the boards, as illustrated on the opposite page
  - The changing players and goalkeepers are out of the play before any change is made.



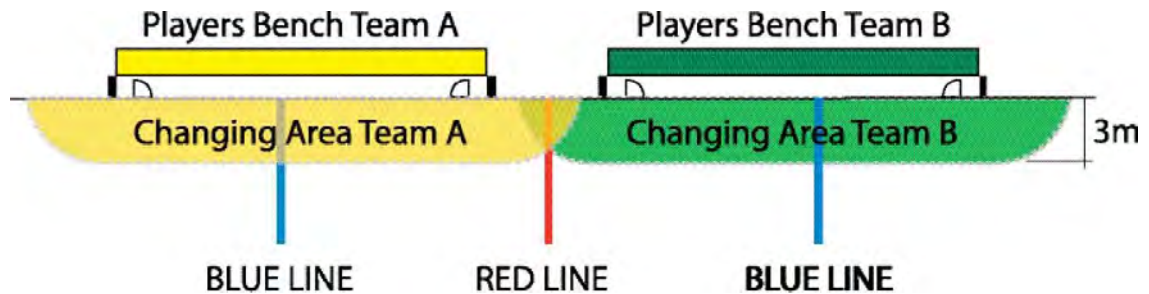

*Figure 32: Changing of players and goalkeepers.*

NEW

b) If, during a player change during game action, a player coming onto the ice or coming off the ice plays the puck, makes contact with an opponent, or participates in game action while both the departing and entering players are on the ice within the **3 metre (10')** zone, a penalty for too many men will be assessed.

c) If, when a goalkeeper leaves his goal crease and proceeds to his team bench for the purpose of substituting another player and if the substitution is made prematurely, the official shall stop the play when the offending team gains possession of the puck. The ensuing face-off shall take place at the centre ice face-off spot, except in the cases where the offending team would gain a territorial advantage, in which case the face-off (see Rule 901 g) shall be where the stoppage of play occurred.

#### **705 Change of player's procedure during stoppage of play**

a) Following a stoppage of play, the visiting team shall promptly place a line-up of players on the ice for play and no substitution shall be made until play has resumed. The home team may then make any desired substitution which does not result in the delay of the game. If there is any undue delay by either team in changing lines, the Referee shall order the offending team or teams to take their positions immediately and shall not permit a line change.

b) The procedure shall be carried out as follows:

1. The Referee shall take his position for the start of the next play, and the Linesman dropping the puck shall proceed promptly to the location of the face-off.
2. The Referee shall allow the visiting team ten seconds to make their player changes.

3. After the ten seconds, the Referee shall raise his arm to indicate that the visiting team shall no longer make a player change.
4. With the arm still up, the Referee shall allow the home team ten seconds to make their player changes.
5. After the ten seconds, the Referee shall drop his arm to indicate that the home team shall no longer make a player change.
6. As soon as the Referee drops his arm, the Linesman conducting the face-off shall blow the whistle, which signals both teams that they shall have no more than five seconds to line-up for the face-off.
7. At the end of the five seconds or sooner if the facing-off players are ready, the Linesman shall drop the puck. It shall not be the responsibility of the Linesman to wait for the players to come into position for the face-off.

c) Teams are not permitted to make a player(s) substitution following a false face-off, except when a penalty is assessed that affects the on-ice strength of either team.

d) A team that is in violation of the icing rule shall not be permitted to make any player substitutions prior to the ensuing face-off.

Should the stoppage of play following the icing infraction coincide with a commercial time-out, or should the offending team elect to utilize their team time-out at this stoppage of play, they are still not permitted to make any player substitutions.

However, a team shall be permitted to make a player substitution to replace a goalkeeper who had been substituted for an extra attacker, or to replace an injured player or goalkeeper, or when a penalty has been assessed which affects the on-ice strength of either team.

The determination of players on the ice will be made when the puck leaves the offending player's stick.

## **706 Change of players from the penalty bench**

A player serving a penalty who is to be changed after the penalty has been served, shall proceed at once, by way of the ice, and be at his own team bench before any change can be made:

- **Bench Minor** penalty (see Rule 1054)

## 707 Change of goalkeepers during stoppage of play

a) During a stoppage of play, goalkeepers shall not be permitted to go to the team bench except to be replaced or during a time out:

- **Minor** penalty (see Rule 1066)

b) When a goalkeeper substitution has been made during a stoppage of play, the goalkeeper who left the game may re-enter the game as soon as the play resumes.

No warm-up shall be permitted for a substitute goalkeeper.

## 8 Safety

### 801 Injured players

a) If a player is injured and cannot continue to play or go to the team bench, the play shall continue until his team has secured possession of the puck, unless either team is in an immediate scoring position, in which case the Referee will allow the scoring opportunity to take place and then stop the play.

b) If a player other than the goalkeeper is injured or compelled to leave the ice during the game, the player/goalkeeper may retire and be replaced by a substitute, but play shall continue without the teams leaving the ice.

c) If a penalized player has been injured he/she may proceed to the dressing room, and if he/she has been assessed a Minor, Major or Match penalty, the penalized team shall immediately put a substitute player on the penalty bench who shall serve the penalty without change, except by the injured penalized player if the player/goalkeeper is able to return.

d) The injured penalized player shall not be eligible to play until his penalty has expired.

e) If an injured player returns to play before his penalty has expired, the Referee shall assess additionally to this player a:

- **Minor** penalty (2')

- If it is obvious that a player has sustained a serious injury, the Referee and/or the Linesman shall stop the play immediately.

- When play has been stopped due to an injured player, excluding the goalkeeper, the injured player shall leave the ice and may not return to the ice until after play has resumed.

- **Minor penalty (2')** (see Rule 1039)

## 802 Injured goalkeepers

a) If a goalkeeper sustains an injury or becomes ill, he/she shall be ready to resume play immediately or be replaced by a substitute goalkeeper.

b) If both goalkeepers of the team are incapacitated and unable to play, the team shall have **(10)** ten minutes to dress another player in uniform as a goalkeeper:

- In this case, neither of the two regular goalkeepers may return to the game
- No warm-up shall be permitted for a substitute goalkeeper.

## 803 Prevention of infections

a) A player bleeding or covered by the blood of an opposing player will be considered as an injured player and must leave the ice for treatment and/or clean up.

b) Such player shall be permitted to return to the ice surface provided that:

- The cut is completely closed and sealed with appropriate bandages
- Any blood is removed from the player and his equipment and uniform replaced or properly cleaned.

If the ice surface, ice rink facilities or any objects are stained with blood, the Referee shall ensure that the bloodstains are removed by the rink personnel after the first stoppage of play.

## 804 Ice cleaning

The Referee has the authority to remove a build-up of snow around the goal post or on the goal line near the net.

## 805 First aid on the ice

**NEW**

The team's qualified trainer or medical expert is designated to provide first aid on the ice, if required. The medical expert or trainer providing first aid will signal with arm(s) extended overhead for help from the event physician in the case of a serious emergency on the ice. Once at the side of the injured athlete, the event physician takes over the care and responsibility of the athlete.

## 9 Playing rules

### 900 Face-offs

### 901 Face-off spots



Figure 33: Location of face-off spots.

- a) A face-off shall be conducted at the beginning of each period and after any stoppage of play.
- b) All face-offs shall be conducted at the nine designated face-off spots
- c) The face-offs shall be conducted at the **centre ice spot**:
  - At the start of a period
  - After a goal scored
  - After an error by an official on icing
  - Premature substitution of a goalkeeper unless otherwise expressly provided by these rules.
- d) Face-offs shall be conducted at the end zone spots of the defending team: **NEW**
  - After any infringement of the rules made by the defending team in his defending zone the puck shall be faced-off at the end zone face-off spot on the side where the stop page occurred
  - A goal illegally scored as a result of a puck deflected off an official

- After an attacking team does not score on a Penalty Shot.
- If a skater on the attacking team takes a shot on goal from anywhere on the ice and the puck, without deflection, hits any part of the goal frame and goes out of play, the ensuing faceoff will take place in the attacking zone at the face-off spot nearest to where the puck was shot.

e) Face-offs shall be conducted at the end zone spots of the attacking team:

- When the puck is iced by the attacking team
- After an **intentional offside** by the attacking team.

Note: An **intentional offside** is made for the purpose of securing a stoppage of play, regardless of the reason

f) Face-offs shall be conducted at the neutral zone spots:

- After an offside
- After any infringement of a rule made by the attacking team in his attacking zone
- Following a stoppage of play, should one or both defensemen who are playing near their attacking blue line or any player coming from the team bench of the attacking team enters into the attacking zone beyond the outer edge of the end zone face-off circles.

g) When players are penalized at a stoppage of play so as to result in penalties being placed on the penalty time clock to one team, the ensuing face-off shall be conducted at one of the two end zone face-off spots in the offending team's end zone. There are only four exceptions to this application:

1. When a penalty is assessed after the scoring of a goal – face-off at centre ice
2. When a penalty is assessed at the very end (or just before the start) of a period - face-off at centre ice
3. When the defending team is about to be penalized and the attacking players enter the attacking zone beyond the outer edge of the end zone face-off circles – face-off in the neutral zone
4. When the team not being penalized ices the puck, the face-off in the neutral zone outside the blue line of the team icing the puck.

## 902 Procedure for conducting face-offs

- a) The Referee or the Linesman will drop the puck between the sticks of the two players facing-off.
- b) The players shall be positioned squarely facing the sideboards of the rink, with their sleds outside of the face-off spot, and with the blade of their stick on the ice on the white part of the face-off spot.
- c) The player of the defending team in his defending half of the rink shall place his/her stick on the ice first followed immediately by the player of the attacking team. **NEW**
- d) However, when the face-off is at the centre ice spot the player of the visiting team shall place his stick on the ice first.
  1. The whistle shall not be blown by the official to start play.
  2. No substitution of players shall be permitted until the face-off has been conducted and play has resumed, except when a penalty is assessed that shall affect the on ice strength of either team.
  3. If the player facing-off fails to take his proper position immediately when directed to do so by the official, the official may order him replaced for the face-off by another team-mate on the ice.
  4. If a player enters the face-off circle, the Referee or Linesman shall blow the whistle to re-face-off the puck, unless the non-offending team gains possession of the puck.
  5. The Referee shall assess the corresponding penalty(s) to the offense made by the player (See Rule 1044 b).

## 903 Offsides

- a) Players of an attacking team **shall not precede the puck** into their attacking zone.
- b) The determining factors in deciding an offside are:
  1. The **player's blades position** - player is offside when both blades are completely over the blue line in his attacking zone before the puck completely crosses the line
  2. The **puck position** - The puck must have completely crossed the blue line into the attacking zone
  3. If a player is propelling the puck and crosses the line ahead of the puck while moving backward, the player is not offside provided he is actually in control of the puck and has both blades in the neutral zone before crossing the blue line

c) In violation of this rule, play shall be stopped and a face-off shall be conducted:

1. At the nearest neutral zone face-off spot if the puck was carried over the blue line by the attacking player
2. At the nearest face-off spot where the pass or shot originated when the puck was passed or shot over the blue line by an attacking player
3. At the end zone face-off spot in the defending zone of the offending team if, in the opinion of the Linesman or Referee, a player has intentionally caused an offside
4. At the end zone face-off spot in the defending zone of the offending team, if the puck was passed or shot by the attacking player from his defending zone.

d) A player actually propelling and in control of the puck, who crosses the line ahead of the puck, shall not be considered offside.

e) If a defending player carries or passes the puck into his defending zone while a player of the attacking team is in an offside position, no offside shall be called.

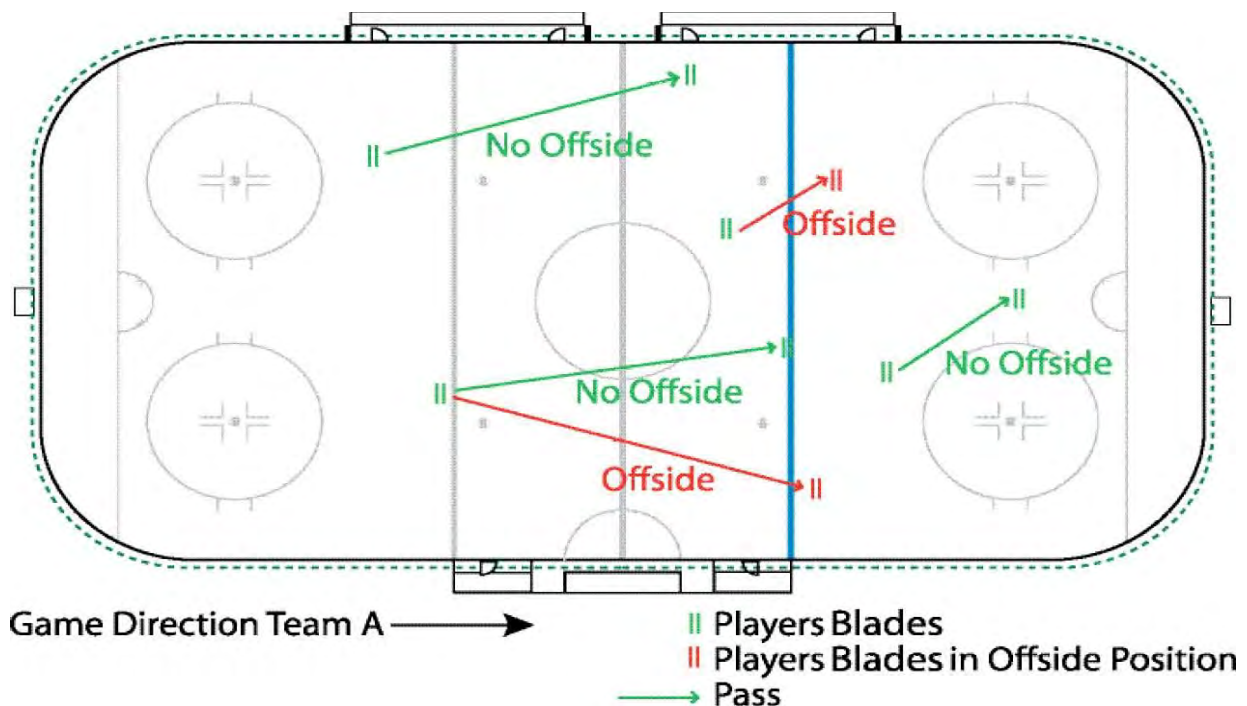

Figure 34: Offsides. This diagram is used with the permission of IIHF.



#### 904 Delayed offside procedure

- a) An attacking player precedes the puck into the attacking zone, but a defending player is able to play the puck, the Linesman shall raise his arm to signal a '**Delayed Offside**', except if the puck has been shot on goal causing the goalkeeper to play the puck.
- b) The Linesman shall drop his arm to nullify the offside violation and allow the play to continue if:
  - 1. The defending team either passes or carries the puck into the neutral zone
  - 2. Or, all attacking players immediately clear the attacking zone by making blade contact with the blue line.
- c) The attacking zone shall be completely clear of attacking players before the delayed offside can be nullified with the puck still in the attacking zone.
- d) 'Immediately' means that the attacking players must not touch the puck, or attempt to gain possession of a loose puck, or force the defending puck carrier further back in the zone.
- e) In this second case, when the Linesman drops his arm, any attacking player may re-enter his attacking zone.

#### 905 Icing the puck/hybrid icing

**NEW**

- a) Should a player of a team equal or superior in numerical strength propel the puck in any manner (including by stick, glove, skate, body) from his half of the ice to beyond the goal line of the opposing team (but not between the goal posts) – including off the boards or the protective glass – without the puck being touched by any player from either team in the opposing team's half of the ice before the puck crosses the goal line (not between the goal posts), an icing will be in effect.
- b) There are two decisions a linesman must make under hybrid icing rules. First, he must determine whether the shot from a player's own side of centre ice will cross the goal line in the attacking zone (not between the goal posts). Second, he must determine whether a defending skater or attacking skater would be first to touch the puck.
- c) This second decision must be made no later than the instant the first of the skaters reaches the end zone face-off spots, although the decision can be made earlier. The blades of the skaters are the determining factor.
- d) Should the puck be shot or propelled in such a way that it travels around the boards and slides back towards centre ice, the linesman will determine which skater would be

first to touch the puck. In this instance, the determining factor is not the end zone face-off spots but the puck itself.

e) If there is no “race” for the puck, icing will be not called until a defending skater crosses his defending blue line and the puck crosses the goal line (not between the goal posts).

f) If the race for the puck is too close to determine which skater from which team would touch the puck first, icing will be called.

g) During an icing situation which results in play being stopped, there must be strict enforcement of rules regarding avoidable contact.

h) During an icing situation where the icing has been cancelled because an attacking skater has gained positional advantage, skaters must compete within the rules pertaining to physical contact.

## 906 Icing

NEW

a) For the purposes of icing, the entire centre red line is part of the offensive half of the ice. Once a skater has “gained the line,” he may shoot the puck the rest of the way down the ice without incurring an icing charge.

b) To “gain the line,” a player must make contact with the centre red line with the puck on his stick (not skate).

c) Only a team that is playing short-handed (i.e., has fewer skaters on ice than its opponent by virtue of penalties) is allowed to shoot the puck from its own side of centre ice to beyond its opponent’s goal line (not between the goal posts) without incurring an icing call.

d) Whether a team is short-handed or not is decided by the number of skaters on ice at the time the puck leaves the player’s stick. If the penalty-box attendant has opened the door at the expiration of a penalty, but the player has not physically stepped onto the ice, he will be considered on the ice as far as interpretation of icing is concerned.

e) A team is not considered short-handed if the number of players on ice is fewer than allowed but that number is not the result of penalties.

f) If the puck hits an on-ice official on its way down the ice, the icing will still be in effect. If, by virtue of hitting an on-ice official, the puck slows down and does not cross the goal line (not between the goal posts), the icing will be nullified.

**g)** After an icing call, the ensuing face-off will take place at the end zone faceoff spot of the offending team nearest to where the players hooting or directing the puck last touched it.

**h)** If the on-ice officials have erred in calling an icing, the ensuing face-off will take place at the centre-ice face-off spot.

**i)** If any of the following situations occur, icing will not be called:

1. If the puck is iced directly by a skater participating in a faceoff;
2. If any opposing skater is able to play the puck before it crosses the goal line (not between the goal posts, including skaters who slow down to ensure the puck crosses the goal line (not between the goal posts) or who pretend to skate fast but don't make a genuine effort to get to the puck before it crosses the goal line);
3. If a player making a line change ignores the puck to go to the bench instead of playing the puck, whether to avoid a penalty for too many men or any other reason;
4. If the puck touches any part of an opponent's body or equipment any time from when it is shot to when it crosses the goal line (not between the goal posts);
5. If a goalkeeper leaves his goal crease during an icing play or is outside his goal crease and moves in the direction of the puck; or
6. If the puck hits the goal frame and crosses the goal line (not between the goal posts).

**j)** If the defending team ices the puck while the attacking team is in a delayed offside situation, icing will be called.

**k)** Following a stoppage of play for an icing infraction, the offending team is prohibited from making any player change until play has resumed.

**l)** A team that is in violation of this rule shall not be permitted to make any player substitutions prior to the ensuing face-off, and even if the offending team elects to utilize their team time-out at this stoppage of play, they are still not permitted to make any player substitutions. However, a team shall be permitted to make a player substitution to replace a goalkeeper who had been substituted for an extra player, to replace an injured player or goalkeeper, or when a penalty has been assessed that affects their on-ice strength. The determination of players on ice will be made when the puck leaves the offending player's stick.

m) If a team persists in changing the players after they have iced the puck, and have been warned by the Referee, the Referee shall assess to the offending team a:

- Bench Minor penalty (2')

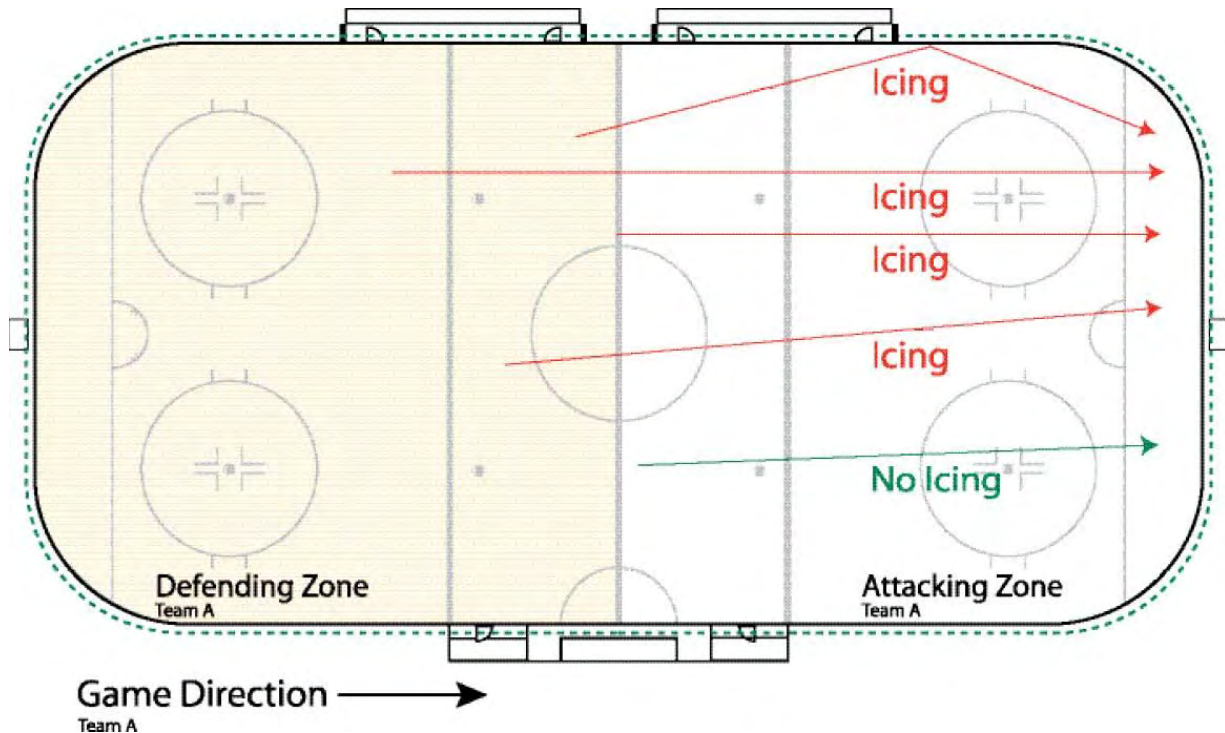

Figure 35: Icing. This diagram is used with the permission of IIHF.

- i. If the Linesmen have made a mistake in calling an icing, the puck shall be faced-off on the centre ice face-off spot.
- ii. The purpose of this section is to enforce continuous action and the Referee and Linesmen shall interpret and apply the rule to produce this result.
- iii. **'Short Handed'** means that due to one or more penalties, the team shall be below the numerical strength of its opponents on the ice.

## 907 Definition of a goal

A goal shall be allowed:

1. When the puck has been put between the goal posts below the crossbar and entirely across the goal line by the stick of a player of the attacking team
2. If the puck has been put into the goal in any way by a player of the defending team

3. If the puck has been deflected into the goal from the shot of an attacking player by striking any part of a teammate
4. If a player of the attacking team has been physically interfered with, by the action of any defending player so as to cause him to be in the goal crease when the puck enters the goal, unless if in the opinion of the Referee, he/she had sufficient time to get out of the crease
5. If the puck should become loose in the goal crease and then put into in the goal by the stick of the attacking player
6. When the puck deflects directly into the goal off the sledge of an attacking or defending player
7. If an attacking player is in the goal crease at the moment the puck crosses the goal line and in no way affects the goalkeeper's ability to make a save, with the exception of the cases described in Rule 908
8. When the puck deflects directly into the goal off the goalkeeper's face mask.

All such calls shall be made by the Referee and he/she may consult with the Linesmen and /or the goal judge.

## **908 Disallowing a goal**

### **a) No goal shall be scored:**

1. If an attacking player deliberately throws, bats with the hands or otherwise directs the puck by any means other than his stick into the goal even if the puck has been further deflected by any player, goalkeeper or official
2. If an attacking player contacted the puck with the stick above the normal height of the top of the head
3. If the puck has been directly deflected into the goal off an official
4. If an attacking skater is in the goal crease at the moment the puck crosses the plane of the goal line, and his position in no way affects the goalkeeper's ability to make a save or play his position properly, the goal will count. **NEW**
5. If an attacking player initiates contact with the goalkeeper, incidental or otherwise, while the goalkeeper is in his goal crease and a goal is scored
6. If an attacking player initiates any contact with the goalkeeper, other than incidental contact, while the goalkeeper is outside his goal crease and a goal is scored

7. Where an attacking player enters or takes a position within the goal crease so as to obstruct the goalkeeper's vision and impair his ability to defend his goal net and a goal is scored

8. Where a goalkeeper has been pushed into the goal together with the puck after making a stop. If applicable, appropriate penalties shall be assessed.

**b) Frame off**

**NEW**

i. If a defending player displaces his goal frame and the opposing team scores a goal, the goal will be allowed provided:

1. The opponent was in the act of shooting prior to the goal frame being displaced;
2. The referee determines the puck would have entered the goal net had the goal frame been in its normal position.

ii. The goal frame is considered displaced if:

1. Either of the two goal pegs is not in its respective hole; or
2. It has come off one or both pegs.

iii. If one or both of the goal posts is not flat on the ice but is in contact with the peg and the peg is in the hole, the goal will count.

iv. For goal frames which do not utilize pegs, the goal posts must be flat on the ice and on the goal line at the time the puck enters the goal net for a goal to count.

v. If a defending player lifts the back of the goal net such that a puck enters the goal net and passes the plane of the goal line, the goal will count so long as rules pertaining to the pegs for the posts are adhered to (Rule 908b-i-iv).

vi. If the position of the goal net is altered in any way during game action, play will be stopped if the goal net does not return to its normal position. If the goal net returns to its normal position, game action will continue.

vii. No goal will be allowed if the goal frame is displaced before the puck crosses the plane of the goal line unless provided by Rule 908c-1.

ix. A goal will be awarded if a goalkeeper has been removed from the ice for an extra skater and a teammate displaces the goal frame from its normal position when an attacking skater is on a breakaway.

c) Where the puck is under the player who is in or around the goal crease (deliberately or otherwise), a goal cannot be scored by pushing this player together with the puck into

the goal. If applicable, the appropriate penalties shall be assessed, including the Penalty Shot (see Rule 1047).

1. No goal shall be disallowed after the face-off immediately following the scoring of that goal.
2. The goal crease is defined as a volume, extending from the crease area on the ice up to **1.27m** above the ice surface.
3. **'Contact'** whether incidental or otherwise, between a goalkeeper and an attacking player may be with the stick or any part of the body or sledge.
4. The Referee may consult with the linesman to aide in determining whether a goal is legal or not.

#### **909 Goal and assist awarded to the player**

- a) A **'Goal'** shall be credited in the scoring records to the player who propelled the puck into the opponent's net.
- b) Each goal shall count one point in the player's record.
- c) When a goal has been scored, an **'Assist'** shall be credited to the player(s) taking part in the play immediately preceding the action.
- d) No more than two assists can be given to any goal.
- e) Each assist shall account for one point in the player's record
  1. Only one point may be awarded to any one player on a goal
  2. Two assists may be awarded when a player scores after a rebound off of the goalkeeper
  3. In the case of an obvious error in awarding a goal or assist, the error shall be corrected promptly, but changes shall not be made once the Referee has signed the Official Game Sheet.

#### **910 Puck out of bounds**

When the puck goes outside the playing area or strikes any obstacles, other than the boards or protective glass above the ice surface, the play will be stopped and the face-off will take place at the nearest point on the imaginary line from where the puck was shot or deflected, unless expressly provided for in these rules.

**911 Puck on the net**

When the puck is lodged in the outside netting of the goal for more than three seconds or held against the goal between opposing players, the Referee shall stop the play and a face-off shall take place:

1. At the nearest end zone face-off spot
2. At the nearest neutral zone face-off spot if, in the opinion of the Referee, the stoppage has been caused by an attacking player.

**912 Puck out of sight**

Should a scramble take place or a player accidentally falls on the puck and the puck is out of sight of the Referee, he/she shall immediately stop the play, and the puck shall be faced-off at the point where the play has been stopped, unless provided for in the rules.

**913 Illegal puck**

If, at any time, while play is in progress, a puck other than the one legally in play shall appear on the playing surface, the play shall not be stopped until the play then in progress is completed by change of possession.

**914 Puck striking an official**

Play shall not be stopped because the puck touches an official except when the puck has entered the goal directly off of an official.

**915 Stopping/Passing the puck with hands**

a) A player shall be permitted to stop or bat the puck in the air with the open hand or push it along the ice with his hand, unless in the opinion of the Referee, the player has deliberately directed the puck to a teammate.

b) If a teammate of such a player obtains possession of the puck in the neutral zone, play shall be stopped and the puck faced-off at the location where the offense occurred, unless the offending team gains a territorial advantage, then the face-off shall be where the stoppage of play occurred.

c) If a teammate of such a player obtains possession of the puck in his defending zone, the Referee shall not stop the play provided the hand pass is completed before the player and the puck leave the zone. However, when the puck is passed with the hand from a player in the neutral zone to a teammate in his defending zone, the Referee shall stop the play with the face-off at the point of stoppage.



d) If a teammate of such a player obtains possession of the puck in his attacking zone, the Referee shall stop the play with the face-off at the neutral zone face-off spot outside the attacking zone unless the puck was batted from the offending team's defending zone or anywhere in the neutral zone, in which case the face-off will take place from where the puck was batted.

e) A goal shall be disallowed if the puck was batted by an attacking player even if deflected into the goal by any player, his stick, sledge, goalkeeper or official into the goal.

#### 916 High sticking the puck

a) Stopping or batting the puck by a player with the stick above the height of the top of the head is prohibited, and the play will be stopped, unless:

1. The puck is batted to an opponent in which case the play shall continue and the Referee shall give the '**Wash Out**' signal
2. A player of the defending team bats the puck into his own goal, in which case the goal is allowed.

b) If the puck has been high-sticked by an attacking player in his attacking zone the faceoff shall take place at the nearest spot in the neutral zone unless the offending team gains a territorial advantage, then the face-off shall be where the stoppage of play occurred.

c) If the puck has been high-sticked by a player in his defending zone or in the neutral zone the face-off shall take place at the nearest defending zone face-off spot.

d) No goal can be scored when the stick of an attacking player makes contact with the puck above the normal height of the top of the head.

e) If a goalkeeper, while in the act of making a save, stops or bats the puck above the height of the top of the head, play shall continue and the Referee shall give the '**Wash Out**' signal.

#### 917 Interference by spectators

a) In the event that objects are thrown on to the ice which interferes with the progress of the game, the Referee shall stop the play and the puck shall be faced-off at the spot the play was stopped.

b) In the event of a player being held or interfered with by a spectator, the Referee or the Linesman shall stop the play. If the team of the player interfered with is in possession of the puck, the play shall be allowed to be completed.

## 10 Penalties

### 1000 Penalties – Definition and procedures

Penalties are divided into the following categories showing time to be served:

- 1) Minor penalty (2)
- 2) Bench Minor penalty (2)
- 3) Major penalty (5)
- 4) Misconduct penalty (10)
- 5) Game Misconduct penalty (GM)
- 6) Match penalty (MP)
- 7) Penalty Shots (PS)

All penalties shall be actual playing time.

a) Penalties imposed after the end of the game shall be reported by the Referee on the Official Game Sheet.

b) Some rules state that the Manager or Coach shall designate a player to serve a penalty. If they refuse to do so, the Referee has the authority to name any player of the offending team who was on the ice at the time of the penalty call to serve the penalty.

c) When the minor or major penalties of two players of the same team terminate at the same time, the Captain of that team shall designate to the Referee which player shall return on the ice first. The Referee will then instruct the scorekeeper accordingly.

d) For a Game Misconduct penalty, a total of **20 minutes** shall be recorded against the penalized player or goalkeeper. For a Match penalty, a total of **25 minutes** shall be recorded against the penalized player or goalkeeper.

e) For all Game Misconduct penalties and Match penalties the Referee shall **file a written report** to the Proper Authorities immediately following the game.

<u>Table of Penalties</u>									
Penalty	Players		Goalkeepers			Remarks			
	Player out for	Served on the penalty bench by	Goalkeeper out for	Served on the penalty bench by	Recorded on game sheet	Observation	Coincidental-penalties		
MINOR	2 Minutes	Offender	-	Player on the ice	2 Minutes	May expire on a goal	May apply		
BENCH MINOR	2 Minutes	Player on the ice	Not applicable	-	2 Minutes	May expire on a goal	May apply		
MAJOR	Balance of the game	Any player except the offending for 5 minutes	Balance of the game	Player on the ice for 5 minutes	5 Minutes	-	May apply		
MISCONDUCT	10 Minutes	Offender	-	Player on the ice	10 Minutes	-	-		
GAME MISCONDUCT	Balance of the game	None	Balance of the game	None	20 Minutes	Report	-		
MATCH	Balance of the game	Any player except the offending for 5 minutes	Balance of the game	Player on the ice for 5 minutes	25 Minutes	Report	May apply		
PENALTY SHOT	-	-	-	-	PENALTY SHOT	-	-		

### 1001 Minor penalty

For a Minor penalty, any player, other than the goalkeeper, will be ruled off the ice for **(2)** two minutes and no substitution shall be permitted.

### 1002 Bench Minor penalty

a) For a Bench Minor penalty, any player who was on the ice at the time of the infraction, other than the goalkeeper of the penalized team, designated by the Manager or the Coach through the Captain, will be ruled off the ice for **(2)** two minutes and no substitution shall be permitted.

b) If, while a team is **'Short Handed'** because of one or more Minor or Bench Minor penalties, the opposing team scores a goal, the first of such penalties shall automatically terminate unless such penalty was assessed at the same time as an opposing player's penalty which originally caused both teams to play one player short, in which case the next Minor or Bench Minor penalty assessed to the scored upon team shall terminate.

1. The designated player shall take his place on the penalty bench promptly and serve the penalty as if it was a Minor penalty imposed to him.
2. **'Short Handed'** means that, due to a penalty(s), the team must be below the numerical strength of its opponents on the ice at the time the goal is scored.
3. This rule does not apply when a goal is scored on a Penalty Shot.

### 1003 Major penalty

For a Major penalty, any player, including the goalkeeper, will be ruled off the ice **for the balance of the game** (*i.e.* will in addition receive a **Game Misconduct penalty**) and substitution shall be permitted after **(5)** five minutes.

When a player is assessed a Major and a Minor penalty at the same time, the Major penalty shall be served first. This applies when both penalties are imposed on the same player (see Rule 1012).

### 1004 Misconduct penalty

a) For his first Misconduct penalty, any player, other than the goalkeeper, shall be ruled off the ice for **(10)** ten minutes and immediate substitution shall be permitted. The player whose Misconduct penalty has expired shall stay on the penalty bench until the next stoppage of play.

b) For his second Misconduct penalty in one game, any player, including the goalkeeper, will automatically be ruled off the ice **for the balance of the game** (*i.e.* will in addition receive a **Game Misconduct penalty**) and immediate substitution shall be permitted.

When a player is assessed a Minor or Major penalty and a Misconduct penalty at the same time, the penalized team shall immediately put a substitute player on the penalty bench to serve the Minor or Major penalty without change.

### 1005 Game Misconduct penalty

For a Game Misconduct penalty, any player, including the goalkeeper or team official, shall be ruled off the ice and ordered to the dressing room **for the balance of the game** and immediate substitution for the player or the goalkeeper shall be permitted.

- A Game Misconduct penalty does not incur automatic suspension, except for that game, but the Proper Authorities shall have the power to suspend the player or the team official from participating in further games.
- In championships and tournament games, any player or team official assessed his second Game Misconduct Penalty shall be automatically suspended for his team's next championship or tournament game.

### 1006 Match penalty

For a Match penalty, any **player, goalkeeper, or team official** shall be ruled off the ice and ordered to the dressing room **for the balance of the game** and substitution shall be permitted after **five minutes**.

- A player or team official incurring a Match penalty shall be awarded an automatic further suspension, which means that he shall be suspended for the next IPC sanctioned game as a minimum and his case shall be dealt with by the Proper Authorities.

### 1007 Penalty shot

a) Five conditions are required to award a penalty shot to a player being fouled from behind:

1. The infraction shall take place when the puck is outside of the player's defending zone (completely across the blue line)
2. The attacking player shall be in possession and have '**control of the puck**'
3. The infraction shall have been committed '**from behind**'
4. The attacking player in possession and control of the puck shall have been denied a reasonable scoring opportunity

5. The player in possession and control of the puck shall have had no opposing players to pass other than the goalkeeper.

b) If the infraction involves a Minor penalty, the penalty shot shall be taken and the Minor penalty will not be assessed or served, regardless of whether the penalty shot results in a goal or not.

c) A penalty shot can be awarded in those situations where a goalkeeper fouls a player on a break-away situation, regardless if the infraction takes place from behind or not.

d) If the infraction involves any other penalty, the penalty shot shall be awarded and the penalty will also be assessed and served regardless of whether the penalty shot results in a goal or not.

1. **‘Control of the puck’** is the act of propelling the puck with the stick. If the puck is touched by another player or his equipment while it is being propelled or hits the goal or goes free, the player shall no longer be considered to be in control of the puck.

2. If, when the opposing goalkeeper has been removed from the ice and a player in **‘control of the puck’** outside his own defending zone, with no opponent to pass between him and the opposing goal net (see also Rule 1027) is fouled from behind, the Referee shall award a goal to the non-offending team.

3. **‘From behind’** is determined by the position of the players’ body and not by the position of the player’s sledge.

### 1008 Penalty shot procedure

a) In cases where a player was fouled in a manner that warrants a penalty shot, the player fouled shall be designated to take the penalty shot. If the fouled player was injured on the play, the Captain shall designate any non-penalized player who was on the ice at the time of the infraction to take the penalty shot.

b) In cases where the player fouled is not identifiable, the Coach or the Captain of the non-offending team selects and reports to the Referee the number of any non-penalized player who was on the ice at the time of the infraction, who shall take the shot.

c) The Referee shall cause to be announced the name and number of the player taking the penalty shot, who cannot be a player serving a penalty or have been assessed a delayed penalty.

d) The players of both teams must skate to their respective benches and leave the ice surface entirely, remaining there during the taking of the penalty shot. Only the two

opposing goalkeepers defending the shots, the skater taking the shot, and the on-ice officials are allowed to be on the ice. NEW

- e) The Referee shall place the puck on the centre spot.
- f) Only a goalkeeper may defend against the penalty shot.
- g) The goalkeeper shall stay in his crease until the player has touched the puck.
- h) The player shall, on instruction of the Referee, play the puck and proceed towards his opponent's goal line and attempt to score on the goalkeeper.
- i) If the player misses the puck and does not touch the puck on the way past it as it sits on the centre face-off dot, the player can return and continue with the penalty shot.
- j) Once the puck is shot the play shall be considered complete, and no goal can be scored by a second shot of any kind.
- k) If a goal is scored, the face-off will take place at centre ice.
- l) If no goal is scored, the face-off will take place at either of the end zone face-off spots in which the penalty shot has been attempted.

Notes:

1. The time required for taking a penalty shot will not be recorded in the actual playing time in any period.
2. If the foul upon which the penalty shot is based occurred during actual playing time, the penalty shot will be awarded and taken immediately in the usual manner, notwithstanding any delay occasioned by a slow whistle by the Referee. In this case, the play shall be permitted to be completed, which delay results in the expiry of the regular playing time in any period.
3. If the goalkeeper leaves his crease before the player has touched the puck, or commits any foul, the Referee shall raise his arm but allow the shot to be completed. If the shot fails, he shall permit the penalty shot to be taken again. If the goalkeeper leaves the goal crease too early, the Referee shall:
  - Issue a warning the first time and a new penalty shot
  - Issue a misconduct penalty the second time and a new penalty shot
  - Award a goal the third time.
4. The goalkeeper shall attempt to block the shot in any manner, except by throwing his stick or any other object, in which case a goal shall be awarded.

5. When the penalty shot is taken, if any player of the opposing team interferes or distracts the player taking the shot, and in the opinion of the Referee because of such action the shot fails, the Referee shall allow a second penalty shot and assess a misconduct penalty on the offending player.

#### **1009 Supplementary discipline**

a) In addition to the suspension imposed under these rules, the Proper Authorities may, at any time after the conclusion of the game, investigate any incident and may assess additional suspensions for any offense committed on or off the ice at any time before during and after the game, whether or not such offenses have been penalized by the Referee.

#### **1010 Goalkeeper penalty procedure**

A goalkeeper never goes to the penalty bench.

a) For Minor or first Misconduct penalties assessed to the goalkeeper:

1. The goalkeeper continues to play
2. His penalty shall be served by another player of his team who was on the ice at the time the play was stopped to assess the penalty for the infraction and was designated by the Manager or Coach through the Captain.

b) For Major, Game Misconduct or Match penalties, the goalkeeper shall be ruled off the ice for the balance of the game.

He shall be replaced by the substitute goalkeeper, if available, or otherwise by a member of his team, who shall be permitted **10 minutes** to dress in the goalkeeper's full equipment.

c) In the case of Major or Match penalties, the **5 minute** penalty shall be served by another player of his team who was on the ice at the time the play was stopped to assess the penalty for the infraction as was designated by the Manager or Coach through the Captain.

1. All penalties imposed to a goalkeeper, regardless of who serves the penalty, shall be charged in the records against the goalkeeper
2. Any additional penalties which were assessed to the goalkeeper at the same stoppage of play shall apply and shall be served by another player of his team who was on the ice at the time the play was stopped to assess the penalty for the infraction.



### 1011 Coincidental penalties

a) When an equal number of identical penalties (Minor, Major or Match) are assessed to both teams at the same stoppage of play, such penalties shall be known as: **Coincidental Penalties**.

b) When such penalties are assessed, immediate substitutions shall be made for those penalties and they shall not be taken into account for the purpose of delayed penalties.

c) In the case where the penalized players remain in the game, they shall take their place on the penalty bench and shall not leave until the first stoppage of play following the expiry of their respective penalties.

d) The above rule will not apply when both teams are at full strength on the ice; no substitution shall be permitted if only one Minor penalty is assessed to one player on each team at the same stoppage of play.

- In the application of this rule, Minor and Bench Minor penalties are considered as identical.

### 1012 Delayed penalty

This rule applies only when Minor, Bench Minor, Major or Match penalties are involved.

a) If a third player of any team is assessed a penalty while two players of his team are serving penalties, he shall leave the ice but his penalty time shall not commence until the penalty time of one of the other players has elapsed.

b) The player shall proceed at once to the penalty bench, but may be replaced on the ice by a substitute.

c) When any team has three or more players serving penalties at the same time, and because of the delayed penalty rule a substitute for the third offender is on the ice, none of the three penalized players may return to the ice until play has been stopped, unless by reason of the expiration of his penalty the penalized team is allowed to have more than four players including the goalkeeper on the ice, in which case the penalized players will be permitted to return in the order of their penalties.

1. If the penalties of two players of the same team expire at the same time, the Captain of the team will designate to the Referee which of the players shall return to the ice first, and the Referee shall instruct the scorekeeper accordingly.

2. When a Major and a Minor penalty are imposed at the same time on two or more players of the same team, the scorekeeper shall record the Minor penalty as being the first of such penalties.

This also applies when the two penalties are imposed on different players (see Rule 1001).

### 1013 Calling of penalties

Should an infraction of the rules be committed which would call for a penalty:

a) If the team of the offending player is in possession of the puck, the Referee shall immediately blow the whistle and assesses the penalty. The face-off shall take place at one of the two end zone face off spots in the offending team's end zone (See Rule 901g).

b) If the team of the offending player is **not** in possession of the puck, the Referee shall raise his arm, signifying the calling of a penalty and, upon possession of the puck by the offending team the Referee shall blow the whistle and assess the penalty.

c) If, after the Referee has raised his arm signifying the calling of the penalty, a goal is scored in any manner against the non-offending team as a result of an action of that team, the goal shall be allowed and a penalty shall be imposed in a normal manner.

d) If, after the Referee has raised his arm signifying the calling of the penalty, a goal is scored by the non-offending team, the goal shall be allowed and the first Minor penalty shall not be assessed. All other penalties shall be assessed. If the offending team is already shorthanded, the first Minor or Bench Minor penalty being served shall be terminated and all penalties being signalled shall be assessed in the normal manner.

e) If after the Referee has signalled a penalty, but before the whistle has been blown, the puck enters the goal of the non-offending team as the direct result of the action of the player of the offending team, the goal shall not be allowed and the penalty signalled shall be imposed.

- **'Possession'** means that the puck shall have come into the possession of, and has been controlled or intentionally directed by a player or goalkeeper of the opposing team, or has been frozen.

- No rebound off of any player of the opposing team, or off the goal or boards, shall be considered as possession

## 1014 Boarding

a) A player who body checks, elbows, or charges an opponent in such a manner that it causes the opponent to be thrown violently into the boards, shall be assessed, at the discretion of the Referee, a:

- **Minor penalty (2')**

Or

- **Major penalty + Automatic Game Misconduct penalty (5'+GM)**

Or

- **Match penalty (MP)**

b) A player who injures his opponent as a result of boarding shall be assessed, at the discretion of the Referee, a:

- **Major penalty + Automatic Game Misconduct penalty (5'+GM)**

Or

- **Match penalty (MP)**

## 1015 Butt ending

a) A player who attempts to butt-end an opponent shall be assessed a:

- **Double Minor penalty + Misconduct penalty (2'+2'+10')**

b) A player who butt-ends an opponent shall be assessed, at the discretion of the Referee, a:

- **Major penalty + Automatic Game Misconduct penalty (5'+GM)**

Or

- **Match penalty (MP)**

c) A player who injures his opponent by a butt-ending shall be assessed a:

- **Match penalty (MP)**

- **'Butt-ending'** identifies the act of a player who uses the shaft of the stick above the upper hand to check an opposing player.

- **'Attempt to butt-end'** shall include all cases when a butt-end gesture is made but no contact is made.

## 1016 Charging

a) A player who runs, charges, or intentionally causes his sled to leave the ice in an attempt to check an opposing player or goalkeeper shall be assessed, at the discretion of the Referee, a:

- **Minor penalty (2')**

Or

- **Major penalty + Automatic Game Misconduct penalty (5'+GM)**

Or

- **Match penalty (MP)**

b) A player who injures his opponent as a result of charging shall be assessed, at the discretion of the Referee, a:

- **Major penalty + Automatic Game Misconduct penalty (5'+GM)**

Or

- **Match penalty (MP)**

1. 'Charging' shall mean the action of a player who, as a result of distance travelled violently checks an opponent. Charging may be the result of a check into the boards, into the goal frame, or on open ice

2. A player who makes physical contact with an opponent after the whistle has been blown, and if, in the opinion of the Referee, the player had sufficient time after the whistle to avoid such contact, shall be assessed, at the discretion of the Referee, a penalty for 'charging'

3. A goalkeeper is not 'fair game' just because he is outside of the goal crease area. A penalty for 'Interference' or 'charging' shall be called in every case where an opposing player makes unnecessary contact with a goalkeeper.

## 1017 Checking from behind

a) A player who runs, charges, or hits an opposing player from behind in any manner shall be assessed, at the discretion of the Referee, a:

- **Minor penalty + Automatic Misconduct penalty (2'+M)**

Or

- **Major penalty + Automatic Game Misconduct penalty (5'+GM)**

Or

- **Match penalty (MP)**

b) A player who injures an opponent as result of checking from behind shall be assessed a:

- **Match penalty (MP)**

1. A '**Check from behind**' is a check delivered on a player who is not aware of the impending hit, is unable to protect himself and contact is made on the back part of the body

2. However, if a player intentionally turns his body to create contact, this shall not be classified as a check from behind.

#### 1018 Checking to the head and neck area

a) A player who directs a check or blow, with any part of his body or equipment, to the head and neck area of an opposing player or 'drives' or 'forces' the head of an opposing player into the boards, shall be assessed, at the discretion of the Referee, a:

- **Minor penalty + Automatic Misconduct penalty (2'+ 10')**

Or

- **Major penalty + Automatic Game Misconduct penalty (5'+GM)**

Or

- **Match penalty (MP)**

b) A player who injures an opponent as result of checking to the head and neck area shall be assessed, a:

- **Match penalty (MP)**

c) This rule supersedes Rules 1014, 1016, 1019, 1020, and 1029 with regards to all actions described under articles a) and b).

Blows to the head area during a fight or altercation are covered and are to be penalized under Rule 1022 Fisticuffs or Roughing.

#### 1019 Cross checking

**NEW**

A '**Cross-check**' is a check delivered with hands on both sticks and no part of either stick on the ice.

a) A player who cross-checks an opponent shall be assessed, at the discretion of the Referee a:

- **Minor penalty (2')**

Or

- **Major penalty + Automatic Game Misconduct penalty (5'+GM)**

Or

- **Match penalty (MP)**

b) A player who injures an opponent by cross-checking shall be assessed, at the discretion of the Referee, a:

- **Major penalty + Automatic Game Misconduct penalty (5'+GM)**

Or

- **Match penalty (MP)**

## 1020 Elbowing

a) A player who uses his elbow to foul an opponent shall be assessed, at the discretion of the Referee, a:

- **Minor penalty (2')**

Or

- **Major penalty + Automatic Game Misconduct penalty (5'+GM)**

Or

- **Match penalty (MP)**

b) A player who injures an opponent by elbowing shall be assessed, at the discretion of the Referee, a:

- **Major penalty + Automatic Game Misconduct penalty (5'+GM)**

Or

- **Match penalty (MP)**

## 1021 Excessive roughness

a) Any player who commits an action not permitted by the rules that may cause or causes an injury to an opponent, to a team or game official shall be assessed a:

- **Match penalty (MP)**

1. The circumstances shall be reported to the Proper Authorities

## 1022 Fisticuffs or roughing

a) A player who intentionally takes off his glove/s in a fight or altercation shall be assessed a:

- **Misconduct penalty (10')**

b) A player who starts fisticuffs shall be assessed a:

- **Match penalty (MP)**

c) A player who, having been struck, retaliates with a blow or attempted blow, shall be assessed a:

- **Minor penalty (2')**

d) Any player or goalkeeper who is the first to intervene in an altercation already in progress, shall be assessed in addition to any other penalties incurred in the incident a:

- **Game Misconduct penalty (GM)**

e) If a player, after he has been ordered by the Referee to stop, continues the altercation, attempts to continue, or resists a Linesman in the discharge of his duties, he shall be assessed, at the discretion of the Referee, a:

- **Double Minor penalty (2'+2')**

Or

- **Major penalty + Automatic Game Misconduct penalty (5'+GM)**

Or

- **Match penalty (MP)**

f) A player or goalkeeper who is on or off the ice and is involved in an altercation or fisticuffs with a player, goalkeeper or team official off the playing surface, shall be assessed, at the discretion of the Referee, a:

- **Misconduct penalty (10')**

Or

- **Game Misconduct penalty (GM)**

Or

- **Match penalty (MP)**

g) A team official who is on or off the ice and is involved in an altercation or fisticuffs with a player, goalkeeper or team official off the playing surface, shall be assessed, at the discretion of the Referee, a:

- **Game Misconduct penalty (GM)**

Or

- **Match penalty (MP)**

h) If a player is deemed guilty of unnecessary roughness, he shall be assessed, at the discretion of the Referee, a:

- **Minor penalty (2')**

Or

- **Double Minor penalty (2'+2')**

Or

- **Major penalty + Automatic Game Misconduct penalty (5'+GM)**

i) A player who grabs or holds the face mask or helmet or pulls the hair of an opponent shall be assessed, at the discretion of the Referee, a:

- **Minor penalty (2')**

Or

- **Major penalty + Automatic Game Misconduct penalty (5'+GM)**

### 1023 Head butting

a) A player who attempts to or deliberately head-butts an opponent shall be assessed a:

- **Match penalty (MP)**

'Attempt to head-butt' shall include all cases when a head-butting gesture is made but no contact is made.

### 1024 High sticking

a) A player who carries or holds his stick or any part of it above the height of his shoulders that makes contact with an opponent shall be assessed, at the discretion of the Referee, a:

- **Minor penalty (2')**



Or

- **Major penalty + Automatic Game Misconduct penalty (5'+GM)**

Or

- **Match penalty (MP)**

b) A player who carries or holds his stick or any part of it above the height of his shoulders that makes contact with an opponent and causes an injury with the stick or any part of it to an opponent shall be assessed, at the discretion of the Referee, a:

- **Major penalty + Automatic Game Misconduct penalty (5'+GM)**

Or

- **Match penalty (MP)**

c) However, if the high sticking action that caused the injury was judged accidental, the offending player shall be assessed a:

- **Double Minor penalty (2'+2')**

#### 1025 Holding an opponent

a) A player who holds an opponent or any part of his sledge with his hands or stick or in any other way shall be assessed a:

- **Minor penalty (2')**

#### 1026 Holding the stick

a) A player who holds an opponent's stick with his hands or in any other way shall be assessed a:

- **Minor penalty (2')**

#### 1027 Hooking

a) A player who impedes or seeks to impede the progress of an opponent by hooking him with his stick shall be assessed, at the discretion of the Referee, a:

- **Minor penalty (2')**

Or

- **Major penalty + Automatic Game Misconduct penalty (5'+GM)**

Or

- **Match penalty (MP)**

b) A player who injures an opponent by hooking shall be assessed at the discretion of the Referee:

- **Major penalty + Automatic Game Misconduct penalty (5'+GM)**

Or

- **Match penalty (MP)**

c) In a 'breakaway' situation, when a player in 'control of the puck' outside his own defending zone has no opponent to pass other than the goalkeeper and he is hooked or otherwise fouled from behind, thus preventing a reasonable opportunity to score, the Referee shall award to the non-offending team, a:

- **Penalty Shot (PS)**

d) If, when the opposing goalkeeper has been removed from the ice, and the player in control of the puck outside of his own defending zone has no opposition between him and the opposing goal is hooked or otherwise fouled from behind, thus preventing a reasonable opportunity to score, the Referee will immediately stop the play and shall award a:

- **Goal**

Notes:

1. A 'Breakaway' shall be defined as situation when a player is in full control of the puck and has no opposing player between himself and the opposing goalkeeper, or goal if the goalkeeper has been removed.
2. 'Control of the puck' is the act of propelling the puck with the stick. If the puck is touched by another player or his equipment while it is being propelled and hits the goal or goes free, the player shall not be longer considered to be in control of the puck.
3. The Referee shall not stop the play until the attacking team has lost possession of the puck.
4. The position of the puck shall be the determining factor. The puck must be fully outside the defending blue line to award a penalty shot or a goal.
5. The intention of this rule is to restore a reasonable scoring opportunity which has been lost by reason of a foul from behind.

## 1028 Interference

a) A player who interferes or impedes the progress of an opponent who is not in possession of the puck shall be assessed a:

- **Minor penalty (2')**

b) A player on either the player's bench or the penalty bench who, by means of his stick or his body, interferes with the movement of the puck of any opponent on the ice during the progress of the play, shall be assessed a:

- **Minor penalty (2')**

c) A player who, by means of his stick or his body, interferes with or impedes the progress of the goalkeeper while he is in his goal crease, shall be assessed a:

- **Minor penalty (2')**

d) If, when the goalkeeper has been removed from the ice, any member of his team, including a team official, interferes by means of his stick, any other object, or his body, with the movement of the puck of an opposing player, the Referee shall award to the non-offending team a:

- **Goal**

Notes:

1. This rule applies to any interference action, such as:

- Knocking a stick out of an opponent's hands
- Preventing a player who lost his stick to regain possession
- Knocking or shooting any abandoned or broken stick or any object towards an opposing puck carrier

2. The last player to touch the puck, other than a goalkeeper, shall be considered having possession of the puck

3. If an attacking player deliberately stands in the goal crease, without interfering with the goalkeeper, the Referee shall stop the play and the ensuing face-off shall take place at the nearest face-off spot in the neutral zone.

e) If an attacking player positions himself facing the opposing goalkeeper and engages in actions such as waving his arms or stick in front of the goalkeeper's face for the purpose of interfering and/or distracting the goalkeeper as opposed to positioning himself to try to

make a play, regardless whether the attacking player is positioned inside or outside of the goal crease, the Referee shall assess a:

- **Minor penalty (2')**

#### 1029 Slashing

a) A player who impedes or seeks to impede the progress of an opponent by slashing with his stick shall be assessed, at the discretion of the Referee, a:

- **Minor penalty (2')**

Or

- **Major penalty + Automatic Game Misconduct penalty (5'+GM)**

Or

- **Match penalty (MP)**

b) A player who injures an opponent by slashing shall be assessed, at the discretion of the Referee, a:

- **Major penalty + Automatic Game Misconduct penalty (5'+GM)**

Or

- **Match penalty (MP)**

c) A player who swings his stick at another player in the course of any altercation shall be assessed, at the discretion of the Referee, a:

- **Major penalty + Automatic Game Misconduct penalty (5'+GM)**

Or

- **Match penalty (MP)**

1. The Referee shall assess a slashing penalty to any player who swings his stick at an opponent without actually striking him, or makes a wild swing at the puck with the object of intimidating an opponent.

2. 'Tapping the stick' of the puck carrier is not considered slashing if it is limited to hitting the stick for the sole purpose of taking the puck.

#### 1030 Spearing

a) A player who 'attempts to spear' an opponent shall be assessed a:

- **Double Minor penalty + Misconduct penalty (2'+2'+10')**

b) A player who spears an opponent shall be assessed, at the discretion of the Referee, a:

- **Major penalty + Automatic Game Misconduct penalty (5'+GM)**

Or

- **Match penalty (MP)**

c) A player who injures an opponent by spearing shall be assessed a:

- **Match penalty (MP)**

'Attempt to spear' shall include all cases when a spearing gesture is made but no contact is made.

'Spearing' is the action of stabbing an opponent with the point of the stick blade, whether or not the stick is being carried with one or both hands.

### 1031 Teeing

a) A player who charges an opponent or who charges the opposing goalkeeper in his crease, using any part of the front radius of his sled shall be assessed, at the discretion of the Referee, a:

- **Minor penalty (2')**

Or

- **Major penalty + Automatic Game Misconduct penalty (5'+GM)**

Or

- **Match penalty (MP)**

Teeing is defined as a player making contact with an opponent with any part of the front radius of his sled straight into an opponent.

### 1032 Tripping

NEW

a) Any player who uses their stick or arm to push/pull/impede an opponent's sledge or blades in any manner causing the player to fall to the ice, lose his/her balance, or lose control of his/her sledge shall be assessed, at the discretion of the Referee, a:

- **Minor penalty (2')**

Or

- **Major penalty + Automatic Game Misconduct penalty (5'+GM)**

### 1033 Abuse of official and unsportsmanlike conduct by players

#### a) If any player:

1. When penalized, does not go directly to the penalty bench or the dressing room
2. While off the ice, uses obscene, profane or abusive language to any official, or any person
3. While off the ice, interferes in any manner with any official. And the player is identifiable he shall be assessed a:

- **Minor penalty (2')**

And the player is not identifiable his team shall be assessed a:

- **Bench Minor penalty (2')**

#### b) A player who:

1. Challenges or disputes the ruling of any official during the game
2. Intentionally shoots the puck out of reach of an official who is retrieving it
3. Enters or remains in the Referee crease while the Referee is reporting to any official shall be assessed a:

- **Misconduct penalty (10')**

For any further dispute, he shall be assessed a:

- **Game Misconduct penalty (GM)**

#### c) If a player on the ice who:

1. Uses obscene, profane or abusive language on the ice or anywhere in the rink before, during or after the game except in the vicinity of the bench.
2. Bangs the boards with a stick or other object at any time
3. Fails to go directly and immediately to the penalty bench following a fight or any altercation which he has been involved or causes any delay retrieving his equipment
4. Persists to incite an opponent into occurring a penalty shall be assessed a:

- **Misconduct penalty (10')**

d) If a player on the ice persists in any course of conduct for which he has been previously assessed a Misconduct penalty, player shall be assessed a:

- **Game Misconduct penalty (GM)**

e) A player who uses or makes any racial remark or ethnic slur shall be assessed a:

- **Game Misconduct penalty (GM)**

f) Any player who:

1. Intentionally touches with hands or stick, holds or pushes or checks with hands, stick or body, trips, slashes, hits in any manner or spits at a game official
2. Makes a travesty of or interferes with or is detrimental to the conducting of the game
3. While on or off the ice or anywhere in the rink before, during or after the game makes any obscene gesture to any official or any person
4. Spits at any person on the ice or anywhere in the rink, shall be assessed a:

- **Match penalty (MP)**

g) If an identified player, who is off the ice, throws a stick or any other object onto the playing surface from the player's bench or from the penalty bench, he shall be assessed a:

- **Minor penalty + Automatic Game Misconduct penalty (2'+GM)**

h) If an unidentified player, who is off the ice, throws a stick or any other object onto the playing surface from the player's bench or from the penalty bench, his team shall be assessed a:

- **Bench Minor penalty (2')**

1. To enforce this rule, the Referee has, in many instances, the following options:

- a. Bench Minor penalty for violations occurring on or in the vicinity of the player's bench, but off of the playing surface and affecting non-playing personnel
- b. Misconduct penalty for violations occurring on the playing surface or in the penalty bench and where the penalized player is readily identifiable

2. The player's gloves and stick or any other equipment shall be delivered to him at the penalty bench by a teammate.

#### **1034 Abuse of officials and unsportsmanlike conduct by team officials**

a) If any team official:

1. Uses obscene, profane or abusive to any official or any person
2. Interferes in any manner with any of the officials of the game

3. Bangs the boards with a stick or other object at any time, the team shall be assessed a:

- **Bench Minor penalty (2')**

b) If the team official persists or is guilty of any type of misconduct the team official shall be assessed a:

- **Game Misconduct penalty (GM)**

c) A team official who uses or makes any racial remark or ethnic slur shall be assessed a:

- **Game Misconduct penalty (GM)**

d) If any team official:

1. Holds or strikes an official

2. Makes a travesty of or is detrimental to the conducting of the game

3. Spits at a game official

4. Makes any obscene gesture to any official or any person, the team official shall be assessed a:

- **Match penalty (MP)**

e) If an identified team official throws a stick or any other object onto the playing surface from the player's bench the team official shall be assessed a:

- **Game Misconduct penalty (GM)**

And player's team a:

- **Bench Minor penalty (2')**

f) If an unidentified team official throws a stick or any other object onto the playing surface from the player's bench, official shall be assessed a:

- **Bench Minor penalty (2')**

### 1035 Broken stick

NEW

a) A player or goalkeeper whose stick is broken shall not receive a stick thrown onto the ice, but may receive a stick from a teammate without proceeding to his player bench.

b) A player with a broken stick may use any portion of the stick to propel himself to his bench for a replacement, while doing so the player must not participate in the play in any manner. If he participates in the play, he shall be assessed a:



- **Minor penalty (2')**

c) A goalkeeper may continue to play with a broken stick until the next stoppage of play or until the goalkeeper has been legally provided with a new stick.

d) If the goalkeeper goes to the bench during a stoppage of play to replace his stick, and then returns back to resume play, he shall be assessed a:

- **Minor penalty (2')**

However, if the goalkeeper is changed for the substitute goalkeeper, no penalty shall be assessed.

e) The goalkeeper is allowed to go to the bench and change his stick when the play is in progress

f) If a player participates in the play while taking a replacement stick to a player or goalkeeper, he shall be assessed a:

- **Minor penalty (2')**

1. A 'broken stick' is one which, in the opinion of the Referee, is unfit for normal play.

2. A player without a stick may participate in the game.

g) If a player, whose stick is broken, receives a stick during play from a team mate in the penalty bench, the receiving player shall be assessed a:

- **Minor penalty (2')**

#### 1036 Captain and alternative Captain complaint

a) If the Captain or Alternate Captain comes to complain about a penalty, whether he was on the ice or he comes from the player's bench, he may at the discretion of the Referee be assessed a:

- **Misconduct penalty (10')**

#### 1037 Delay of game – Adjustment of equipment

a) Play shall not be stopped nor the game delayed by reason of repair or adjustments to player's equipment and uniform, and the player requiring such adjustments shall retire from the ice.

b) Play shall not be stopped nor the game delayed by reason of repair or adjustments to goalkeeper's equipment and uniform, and the goalkeeper requiring such adjustments shall retire from the ice and the substitute goalkeeper shall take his place immediately

c) For any infraction to this rule the player or goalkeeper shall be assessed a:

- **Minor penalty (2')**

#### 1038 Delay of game – Displacing the goal frame

a) A player or goalkeeper who deliberately displaces the goal frame from its normal position shall be assessed a:

- **Minor penalty (2')**

b) If it happens during the last two minutes of the game, or at any time in overtime, by a defending player or goalkeeper in his defending zone the Referee shall award to the non-offending team a:

- **Penalty Shot (PS)**

c) If a player or goalkeeper deliberately displaces the goal frame from its normal position when an opponent is in control of the puck with no opposition between him and the goalkeeper, and with a reasonable opportunity to score, the Referee shall award to the non-offending team a:

- **Penalty Shot (PS)**

d) If a player of the defending team deliberately displaces the goal, and, in the opinion of the Referee, the puck would have entered the goal had it not been displaced, or if the defending team deliberately displaces the goal when the goalkeeper is off the ice hereby preventing an obvious and imminent goal, the Referee shall award to the non-offending team a:

- **Goal**

e) If, when a goalkeeper has been removed from the ice, a player of his team displaces the goal frame from its normal position when an opponent is in control of the puck with no opposition between him and the goal, the Referee shall award to the non-offending team a:

- **Goal**

f) If at any time during the course of the penalty shot (which begins when the Referee blows the whistle for the player to start the shot) the goalkeeper deliberately moves or dislodges the goal net, the Referee shall award to the non-offending team a:

- **Goal**

**1039 Delay of game – Injured player refusing to leave the ice**

a) An injured player who refuses to leave the ice shall be assessed a:

- **Minor penalty (2')**

**1040 Delay of game – Keeping the puck in motion**

a) The puck must be kept in motion at all times. A team in possession of the puck in its own defending zone shall advance the puck towards the opposing goal except:

1. To carry the puck behind his goal once
2. If it is prevented to do so by players of the opposing team
3. If the team is short handed

b) A player beyond his defending zone shall not pass or carry the puck backward into his defending zone for the purpose of delaying the game, except when his team is short handed

For the first infraction, the Referee shall assess a:

- **Warning to the Captain of the offending team**

For the second infraction, during the same period, the offending player shall be assessed a:

- **Minor penalty (2')**

c) Any player or goalkeeper who holds or plays the puck with his stick, sledge or body along the boards in such a manner to cause a stoppage of play, unless he is actually checked by an opponent, shall be assessed a:

- **Minor penalty (2')**

**1041 Delay of game – Late line up**

a) If a team, after the end of an intermission, does not line up on the ice surface the required number of players to start a period (or overtime) the team shall be assessed a:

- **Bench Minor penalty (2')**

**1042 Delay of game – More than one change after goal scored**

a) If a team after scoring a goal has more than one change of players on the ice it shall be assessed a:

- **Bench Minor penalty (2')**

#### 1043 Delay of game – Shooting or throwing the puck outside the playing area

a) When any player or goalkeeper, while in his defending zone, shoots, throws or bats the puck with his hand or stick directly, (non-deflected) out of the playing area, except where there is no glass, he shall be assessed a:

- **Minor penalty (2')**

b) When the puck is shot, thrown or batted with the hands or stick by a player or goalkeeper into the player's bench (or penalty bench if there is no protective glass), no penalty shall be assessed.

c) When the puck is shot, thrown or batted with the hands or stick by a player or goalkeeper over the glass, behind the player's bench (or penalty bench) the penalty shall be assessed.

d) A Minor penalty for delay of game shall be imposed on any player or goalkeeper who deliberately shoots or bats the puck outside the playing area during the play or after a stoppage of play unless covered by this rule.

#### 1044 Delay of game – Violation of face-off procedures

a) When a player has been removed from the face-off by an official and another player of the same team delays taking up his proper position after a 'warning' the offending player shall be assessed a:

- **Minor penalty (2')**

b) When a player not taking the face-off enters the face-off circle before the puck is dropped, the player of his team taking the face-off shall be removed and replaced. For the second violation during the same face-off, the offending player shall be assessed a:

- **Minor penalty (2')**

#### 1045 Diving

a) Any player who, at the discretion of the Referee, embellishes an infraction, flagrantly imitates a fall, a reaction, or feigns an injury in an attempt to draw a penalty by his action, shall be assessed a:

- **Minor penalty (2')**

#### 1046 Illegal or dangerous equipment

a) A player or goalkeeper who:

1. Wears his equipment or facemask in a way that may cause an injury to an opponent

2. Wears any non-approved equipment
3. Uses or wears illegal or dangerous sledges, sticks or equipment
4. Does not wear his equipment, except gloves, head protection and goalkeeper leg guards, entirely under his uniform
5. Wears a glove in play from which all or part of the palm has been removed or cut to permit the use of a bare hand:

Shall be ruled off the ice and a '**warning**' shall be issued to his team.

b) The Referee can request that a player or goalkeeper remove any personal accessories should the personal accessories worn during the game be regarded as dangerous for the player and other participants. If these accessories are difficult to remove, then the player or goalkeeper shall tape the personal accessories or put the item(s) safely under the jersey in such a way that they are no longer dangerous. In this case, the player or goalkeeper shall be ruled off the ice and a '**warning**' shall be issued to his team.

- The guilty player shall not be allowed to participate in the game until the illegal equipment has been corrected or removed.

c) For a second violation by any player or goalkeeper of the same team for any offense of this rule mentioned above, the Referee shall assess to the offending player or goalkeeper a:

- **Misconduct** penalty (10')

d) If a player or goalkeeper refuses to surrender or destroys his stick or any part of his equipment for measurement when requested by the Referee, this equipment shall be regarded as illegal and the player or goalkeeper shall be assessed a:

- **Minor** penalty + **Misconduct** penalty (2'+10')

e) If a team has requested the measurement of any equipment of the opposing team and if the complaint is sustained the offending player shall be assessed a:

- **Minor** penalty (2')

1) Measurement of sticks

**NEW**

A request may be made by a team to measure a stick at any time during the game at any stoppage of play.

2) Measurement of other equipment

A request may be made by a team to measure equipment (with the exceptions of sticks). If the request is made during the first or second period, the equipment will be measured by the proper authorities during the next intermission. Any request in either the third period or overtime will be measured immediately. All equipment measurements will be conducted either by the Referee or the designated tournament/game official.

f) If a team has requested the measurement of any equipment of the opposing team and if the complaint is not sustained the team shall be assessed a:

- **Bench Minor penalty (2')**

g) A player on the ice whose helmet comes off during play and who does not put the helmet back on with chin strap properly fastened, or does not return to his bench, and participates in the play in any manner shall be assessed a :

- **Minor penalty (2')**

#### 1047 Falling on the puck by a player

a) If a player, other than the goalkeeper, deliberately falls on, holds or gathers the puck into his body, he shall be assessed a:

- **Minor penalty (2')**

b) If, during the course of a face-off, a player deliberately falls on, gathers the puck into his body, or uses his body or sled to protect the puck from the opposing player, he shall be assessed a:

- **Minor penalty (2')**

c) If a defending player, other than the goalkeeper, deliberately falls on, holds or gathers the puck into his body when the puck is in the goal crease of his team, the Referee shall award to the non-offending team a:

- **Penalty Shot (PS)**

d) If the opposing goalkeeper has been removed from the ice and a player deliberately falls on, holds or gathers the puck into his body when the puck is in the goal crease of his team, the Referee shall award to the non-offending team a:

- **Goal**

A player who drops on the ice to block a shot shall not be penalized if the puck is shot under him or becomes lodged in his clothing or equipment, but any use of the hands to make the puck un-playable shall be penalized.

## 1048 Falling on the puck by a goalkeeper

NEW

a) If a goalkeeper, whose body is entirely outside the goal crease, and when the puck is behind the goal line or beyond the two lines on each side of the face-off circles, deliberately falls on or gathers the puck into his body, or holds or places the puck against any part of the goal or the boards, he shall be assessed a:

- **Minor penalty (2')**

b) If the goalkeeper falls or gathers the puck into his body in the area between the goal line and the hash marks (as shown in Figure 36) unless he is being pressed, he shall be assessed a:

- **Minor penalty (2')**

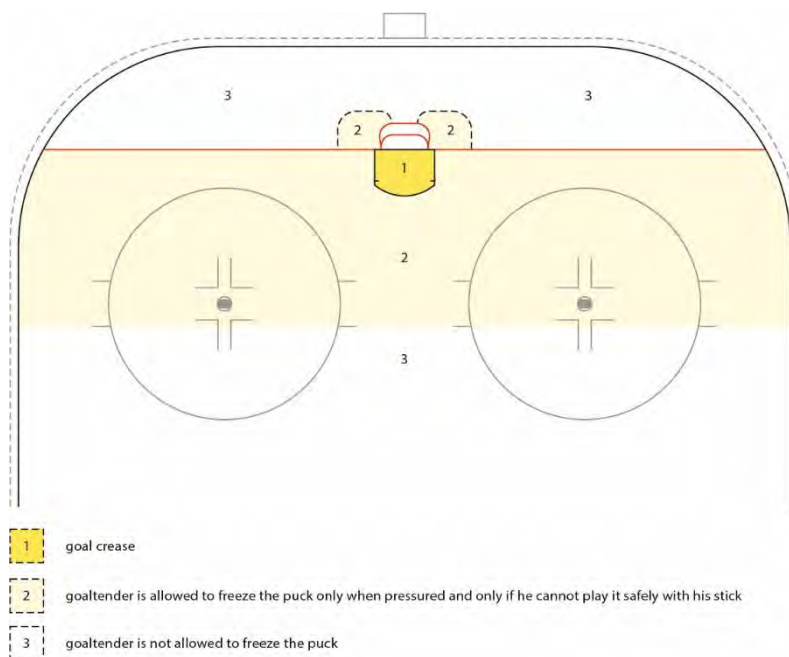

Figure 36: This diagram is used with the permission of IIHF.

## 1049 Handling the puck with hands by a player

a) Any player, except the goalkeeper, who closes his hand on the puck, or places a closed hand on top of the puck, and while doing so gains an advantage on an opponent shall be assessed a:

- **Minor penalty (2')**

b) Any player, except the goalkeeper, who picks up the puck from the ice with their hands, shall be assessed a:

- **Minor penalty (2')**

c) If any defending player, except the goalkeeper, picks up the puck with his hands from the ice in his goal crease, the Referee shall award to the non-offending team a:

- **Penalty Shot (PS)**

d) If the goalkeeper is not on the ice as in section 'c' of this rule, the Referee shall award to the non-offending team a:

- **Goal**

e) A player is permitted to stop, bat or push the puck along the ice with his hands. However, No Goal shall be awarded if the puck was batted by an attacking player with the hand, even if it deflects off of any player or goalkeeper or the sticks of the players or goalkeeper of either team or official.

#### 1050 Handling the puck with hands by a goalkeeper

a) Unless he is being pressured, a goalkeeper who holds the puck more than three seconds shall be assessed a:

- **Minor penalty (2')**

b) If a goalkeeper throws the puck forward and the puck is first played by a team-mate, the Referee will immediately blow the whistle to stop the play and an end zone face-off will be held.

c) A goalkeeper who deliberately drops the puck into his pads, sledge or any part of his equipment shall be assessed a:

- **Minor penalty (2')**

The object of this rule is to keep the puck in play continuously and any action by the goalkeeper which causes an unnecessary stoppage of play shall be penalized.

#### 1051 Infringement of change of players procedure

a) Where a team attempts to make a player(s) change after its allotted period of time, the Referee shall send the player(s) back to the bench and issue a '**warning**' to the team.

b) Any further infraction(s) of this procedure at any time during the course of the game shall be assessed to the offending team a:

- **Bench Minor penalty (2')**



#### 1052 Interference with spectators

a) A player who physically interferes with a spectator shall be assessed, at the discretion of the Referee, a:

- **Match penalty (MP)**

#### 1053 Players leaving the penalty or player's bench

a) Any player, other than as specified in Rule 1055, who leaves the penalty bench or player's bench and incurs a Minor, Major or Misconduct penalty for his actions, shall be automatically assessed a:

- **Game Misconduct penalty (GM)**

b) If a player or goalkeeper illegally enters the game and interferes with a player of the opposing team possession of the puck, who has no opponent between him and the goalkeeper, the Referee shall award to the non-offending team a:

- **Penalty Shot (PS)**

c) If, when the opposing goalkeeper has been removed from the ice, a player illegally enters the game and interferes with a player of the opposing team in possession of the puck, the Referee shall award to the non-offending team a:

- **Goal**

1. If a player shall illegally enter the game from his own player's bench or from the penalty bench by his own error or the error of the Penalty Bench Attendant, any goal scored by his own team shall be disallowed, while he is illegally on the ice, but all penalties imposed to both team shall be served.

2. If the player leaves the penalty bench because of an error of the Penalty Bench Attendant, he shall not be penalized but shall serve the remaining amount of time of his penalty when he re-entered the game.

3. The Penalty Bench Attendant shall note the time and advise the Referee at the first stoppage of play.

#### 1054 Players leaving the penalty bench

a) Except at the end of a period, a penalized player who leaves the penalty bench before his penalty time has expired shall be assessed a:

- **Minor penalty (2')**

b) If the violation occurs during a stoppage of play during an altercation, the offending player shall be assessed a:

- **Minor penalty + Game Misconduct penalty (2'+GM)** to be served at the expiration of his previous penalty.

c) If a player serving a penalty on the penalty bench is to be changed after the penalty has been served, and does not proceed at once by way of the ice to his own player's bench before any change is made, his team shall be assessed a:

- **Bench Minor penalty (2')**

d) Any player who, having entered the penalty bench, leaves the penalty bench prior to the expiration of his penalty for the purpose of challenging an official's ruling, shall be assessed a:

- **Minor penalty + Game Misconduct penalty (2'+GM)**

#### 1055 Players leaving the benches during an altercation

a) No player shall leave the players or penalty bench at any time during an altercation.

b) The first player to leave the players or penalty bench during an altercation shall be assessed a:

- **Double Minor penalty + Game Misconduct penalty (2'+2'+GM)**

c) Any other player or players who leave(s) the players or penalty bench during an altercation shall be assessed a:

- **Minor penalty + Misconduct penalty (2'+10')**

1. Substitutions made prior to the altercation shall be permitted provided the players so substituting do not enter the altercation.

2. If players of both teams leave their respective benches at the same time, the first identifiable player of each team will be penalized under this rule.

3. For the purpose of determining which player was the first to leave his player's bench, the Referee shall consult the Linesmen and/or off-ice officials.

4. A **maximum** of five Misconduct and/or Game Misconduct penalties **per team** can be assessed under this rule.

#### 1056 Prevention of infections by blood

a) A player bleeding or covered by blood of any player shall be considered as an injured player and shall leave the ice for treatment and/or cleaning. If he does not comply with this regulation he shall be assessed a:

- **Minor penalty (2')**

Such player shall be permitted to return to the ice surface provided that:

1. The cut is completely closed and sealed with appropriate bandages
2. Any blood is removed from the player and his equipment and uniform replaced or properly cleaned.

b) If the ice surface, ice rink facilities or any objects are stained with blood, the Referee shall ensure that the bloodstains are removed by the rink personnel after the first stoppage of play.

#### 1057 Team officials leaving the player's bench

Any team official who goes on the ice during any period without the permission of the Referee shall be assessed a:

- **Game Misconduct penalty (GM)**

Where an injury has occurred to a player and there is a stoppage of play, a team doctor (or designate) may go on the ice to attend to the injured player.

#### 1058 Refusing to start play – Team on the ice

a) If, when both teams are on the ice and one team refuses to play for any reason when ordered to do so by the Referee, the Referee shall warn the Captain and allow to the team so refusing 30 seconds to begin the game or resume play.

b) If, at the end of that time the team still refuses to play, the Referee shall assess a:

- **Bench Minor penalty (2')**

c) If there be a recurrence of the same incident, the Referee will declare the game forfeited to the non-offending team and the case shall be reported to the:

- Proper Authorities

**1059 Refusing to start play – Team not on the ice**

a) If a team, which is not on the ice, fails to go on the ice to start playing when ordered by the Referee through the Captain, Manager or Coach, the Referee shall allow to the refusing team two minutes to resume the game.

b) If the team resumes play within these two minutes, the Referee shall assess to the offending team a:

- **Bench Minor penalty (2')**

c) If, at the end of that time the team still fails to go on the ice, the Referee shall declare the game forfeited to the non-offending team and the case shall be reported by the Referee to the Proper Authorities immediately after the game.

**1060 Throwing a stick or any object out of the playing area**

a) Any player or goalkeeper who throws a stick or part of it, or any other object out of the playing area shall be assessed a:

- **Game Misconduct penalty (GM)**

**1061 Throwing a stick or any object within the playing area**

a) Any player or goalkeeper on the ice or on the bench or team official, who shoots or throws a stick or any part of it, or any other object, or who directs (with any part of the body) a stick, any part of it, or any object in the direction of the puck or puck carrier in the attacking zone of his team, or in the neutral zone shall be assessed a:

- **Minor penalty (2')**

Or

- **Bench Minor penalty (2')**

b) If any player, goalkeeper or team official commits any of the actions described in section a) of this rule in his defending zone, the Referee shall award to the non-offending team a:

- **Penalty Shot (PS)**

c) If the goalkeeper intentionally leaves his stick or any part of it, or any other object in front of his goal, and if the puck hits such objects while the goalkeeper is on or off the ice, the Referee shall award to the non-offending team a:

- **Goal**

d) If a stick or any part of it, or any object is thrown, shot or directed (with any part of the body) away by a player or goalkeeper on the ice and in no way interferes with the play, no penalty shall be assessed to the player or goalkeeper.

e) When a player on the ice, or player/goalkeeper on the bench, or team official throws or shoots a stick, or any part of it, or any object, or who directs (with any part of the body) a stick, or any part of it, or any object in the direction of the puck or puck carrier in any zone when the goalkeeper has been removed from the ice, the Referee shall award the non-offending team a:

- Goal

f) When a player or goalkeeper discards the broken portion of a stick by tossing it to the side of the rink (and not over the boards) in such a way not to interfere with play or an opposing player, no penalty shall be imposed for such action.

Note: The position of the puck or puck carrier at the moment when a stick or any part of it, or any object is thrown, shot or directed (with any part of the body) by an opposing player in the direction of the puck or puck carrier is the determining factor whether to assess a Minor penalty or award a penalty shot. When the goalkeeper has been removed from the ice, refer to section e) of this rule.

## 1062 Throwing a stick or any object on a breakaway situation

a) When a player in control of the puck outside his own defending zone, and having no opponent to pass other than the goalkeeper, and any member of the opposing team, including team officials, throws or shoots a stick, any part of it, or any other object or who directs (**with any part of the body**) a stick or any part of it, or any object in the direction of the puck or puck carrier, the Referee shall award to the non-offending team a:

- Penalty Shot (PS)

1. The position of the puck shall be the determining factor in this instance. The puck shall be fully outside the defending zone blue line in order to award a penalty shot or a goal.

b) When the actions described in section (a) of this rule are committed against a player in control of the puck outside his own defending zone when the goalkeeper has been removed from the ice, the Referee shall award to the non-offending team

- Goal

### 1063 Too many players on the ice

a) If, at any time during play a team has more than the number of players on the ice to which they are entitled, the team shall be assessed a:

- **Bench Minor penalty (2')**

b) If, in the last two minutes of the game and at any time in overtime a deliberate illegal substitution (too many players on the ice) is made, the Referee shall award to the non-offending team a:

- **Penalty Shot (PS)**

### 1064 Penalties for goalkeepers

The procedures for goalkeeper penalties are outlined in Rule 1010. Specific penalties for a goalkeeper are outlined in the following rules:

- 1008 Penalty shot procedure
- 1035 Broken stick
- 1038 Displacing the goal frame
- 1040 Keeping the puck in motion
- 1043 Shooting or throwing the puck outside the playing area
- 1048 Falling on the puck
- 1050 Handling the puck with hands
- 1060 to 1061 Throwing a stick or any object
- 1065 Goalkeeper beyond the centre red line
- 1066 Goalkeeper going to the player's bench during stoppage of play
- 1067 Goalkeeper leaving the goal crease during an altercation
- 1068 Goalkeeper dropping the puck on the goal netting

### 1065 Goalkeeper beyond the centre red line

If a goalkeeper participates in the play in any manner when he is beyond the centre red line, he shall be assessed a:

- **Minor penalty (2')**

The position of the goalkeeper's blades shall be the determining factor for the purpose of this rule.

#### 1066 Goalkeeper going to the players' bench during stoppage of play

If a goalkeeper goes to the player's bench during a stoppage of play, except to be replaced or during a time out, his team shall be assessed a:

- **Bench Minor penalty (2')**

#### 1067 Goalkeeper leaving the crease during an altercation

If a goalkeeper leaves the immediate vicinity of his crease during an altercation, unless directed to do so by the Referee, he shall be assessed a:

- **Minor penalty (2')**

#### 1068 Goalkeeper dropping the puck on the goal netting

If a goalkeeper drops the puck on the goal netting to cause a stoppage of play he shall be assessed a:

- **Minor penalty (2')**

#### 1069 Protection of the goalkeeper

a) In all cases which an attacking player initiates any intentional contact with the goalkeeper when the goalkeeper is inside his goal crease and whether or not a goal is scored, the attacking player shall be assessed the appropriate penalty.

b) A goalkeeper is **not 'fair game'** just because he is outside of the goal crease. The penalty shall be assessed in every case where an attacking player makes unnecessary contact with the goalkeeper (see Rule 1016). Incidental contact shall be permitted when the goalkeeper is in the act of playing the puck outside his goal crease provided the attacking player made a reasonable effort to avoid unnecessary contact.

c) Where a goalkeeper has played the puck outside his goal crease and is then prevented from returning to his crease due to the action of an attacking player other than incidental, such a player shall be assessed the appropriate penalty.

d) A goalkeeper shall be penalized if, by his actions outside the crease, he interferes with an attacking player who is attempting to play the puck or an opponent:

e) If an attacking player has been pushed, shoved or fouled by a defending player so as to cause him to come into contact with the goalkeeper, such contact shall not be deemed to be initiated by the attacking player, provided the attacking player has made a reasonable effort to avoid such contact with the goalkeeper.

f) However, where an attacking player stands in the goal crease, play shall be stopped and a face-off shall take place in the nearest face-off spot in the neutral zone.

1. All calls concerning this rule shall be based strictly on the judgment of the Referee.

2. '**Contact**' whether incidental or otherwise between the goalkeeper and an attacking player may be with a stick or any part of the body.



## 11 Referee and linesmen signals

### Referee signals

#### Boarding – Rule 1014

Striking the clenched fist of one hand into the open palm of the opposite hand in front of the chest.



#### Butt-ending – Rule 1015

A cross motion of the forearms, one moving under the other. Upper hand is open and the lower hand a clenched fist.



#### Player change signal – Rule 705

The Referee allows a ten second period to the visiting team to make a player(s) change. After the ten seconds, the Referee will raise his arm which indicates that the visiting team may no longer change any player and the home team has ten seconds to change players.

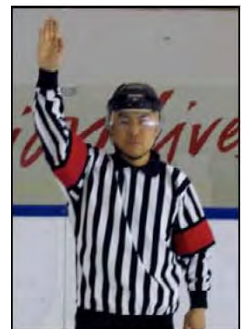

#### Charging – Rule 1016

Rotating clenching fists around one another in front of the chest.



### Checking from behind – Rule 1017

A forward motion of both arms, with the palms of the hands open and facing away from the body, fully extended from the chest at shoulder level.



### Cross-checking – Rule 1019

A forward and backward motion of the arms with both fists clenched, extending from the chest for a distance of about a half a meter.



### Delayed calling of penalty – Rule 1012

Extended the non-whistle arm fully above the head. It is acceptable to point at the player once and then extend the arm above the head.

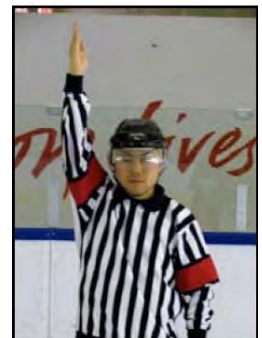

### Elbowing – Rule 1020

Tapping either elbow with the opposite hand.



**Puck in the net – Rule 907**

A single point directed at the goal in which the puck legally entered.



**Hand pass – Rule 914**

Use open palm of hand in a pushing motion.

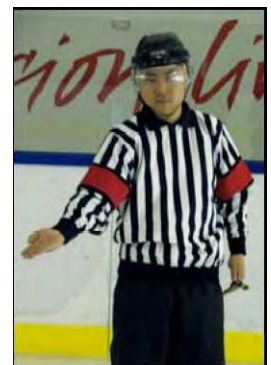

**High sticking – Rule 1024**

Holding both fists clenched one immediately above the other at the height of the forehead.



**Holding – Rule 1025**

Clasping either wrist with the other hand in front of the chest.



### Holding the stick – Rule 1026

Two stage signal followed by a signal indicating you are holding onto a stick with two hands in a normal manner.



### Hooking – Rule 1027

A tugging motion with both arms as if pulling something from in front towards the stomach.



### Interference – Rule 1028

Crossed arms with closed fists stationary in front of the chest.

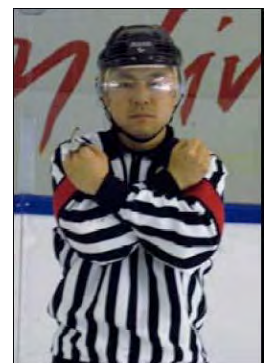

### Match penalty – Rule 1006

Patting the flat of the hand on top of the head.



**Misconduct penalty – Rules 1004, 1005**

Both hands on hips. The same signal for unsportsmanlike conduct, ten minute Misconduct, Game.

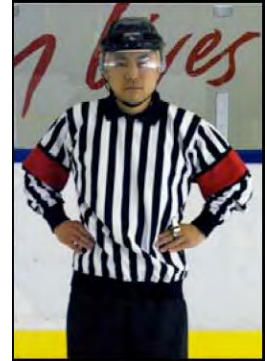

**Penalty shot – Rule 1008**

Arms crossed above the head. Give the signal upon stoppage of play.



**Roughing – Rule 1022**

Fist clenched and arm extended out to the side of the body.



**Slashing – Rule 1029**

A chopping motion with the edge of one hand across the opposite forearm.

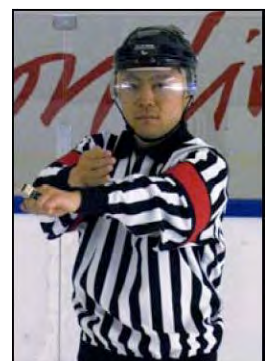

**Spearing – Rule 1030**

Jabbing motion with both hands thrust out immediately in front of the body and the hands dropped to the side of the body.



**Teeing – Rule 1031**

Striking the clenched fist of one hand into the fore arm of the opposite arm in front of the chest.



**Time out – Rule 602**

Using both hands to form a 'T' in front of the chest.



**Too many players on the ice – Rule 1063**

Indicate with six fingers (one hand open) in front of the chest.



### Checking to the head and neck area – Rule 1018

The side movement of the open palm of the hand towards the side of the head.



### Wash out

A sweeping sideways motion of both arms across the front of the body at the shoulder level with palms down:

- By the Referee to signal 'no goal', 'no hand pass', 'no high sticking the puck'
- By the Linesman to signal 'no icing' and,
- In certain situations, 'no offside'.



### Delay of game – Rule 1037-1044

Placing the non-whistle hand, open palm, across the chest and extended from the shoulder out from the body.



### Tripping – 1032

The upper hand is in front of the chest with a closed fist. The lower hand begins stretched out in front and then rotates under the upper hand with the palm open and facing down.

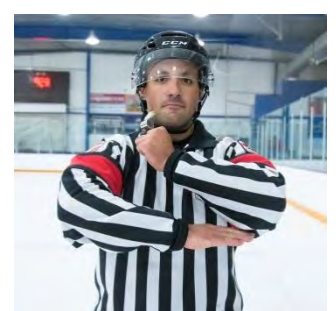

## Linesman's signals

### Delayed offside – Rule 904

Non-whistle arm fully extended above the head to nullify a delayed offside the Linesman shall drop the arm to the side.

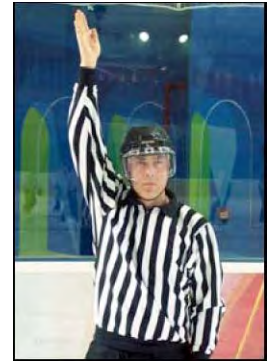

### Icing the puck/hybrid icing – Rule 905-906

The back Linesman (or Referee in the two-man system) signals a possible icing by fully extending either arm over his head. The arm should remain raised until the front Linesman or Referee, either blows the whistle to indicate an icing, or until the icing is washed out. Once the icing has been completed, the back Linesman or Referee will first cross his arms in front of the chest and then will point to the appropriate face-off spot and skate to it.



### Offside call – Rule 903

The official will first blow the whistle and then point toward the blue line.





## Appendix 1: Measurement tools and standards

### 1. Sledge height measurement

The measurement tool shown below may be designed of any material, with the height dimensions of **8.5cm minimum** and **9.5cm maximum**. It is recommended the tool be **15cm** long and **2cm** wide for stability.

To secure a proper frame measurement:

- Place sledge on a stable flat surface
- Apply pressure to the centre of the bucket
- Run/slide measurement tool along the flat surface underneath. The frame cannot sit below **8.5cm** and cannot rise above **9.5cm**.

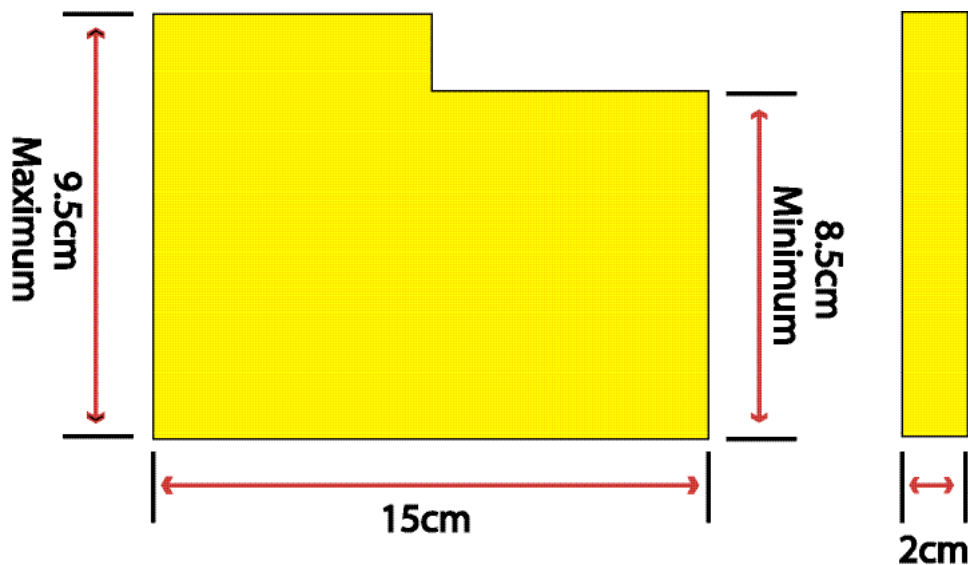

### 2. Measurements of diameters of cylindrical shapes

To measure the diameter of cylindrical shapes a segmometer must be used.

### 3. Sledge length measurement standard

Sledge length measurements will be conducted in the following order:

- a) The sledge will be placed with the bucket touching a solid flat surface.
- b) A solid block designed of any material, will be placed, touching the front of the frame.

c) A standard measuring tape shall be drawn along the ground from the front edge of the frame, as indicated in the diagram below:

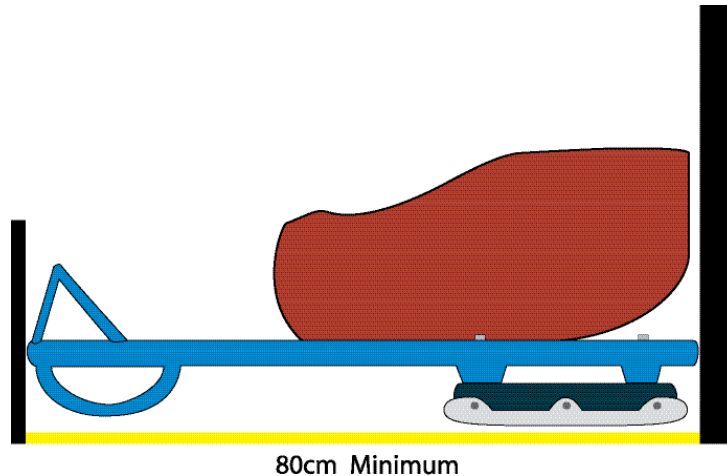

#### 4. Pick measurement tool

The pick measurement tool may be designed of any material. The tool must indicate a height of **1cm** and indicate a depth of the teeth on the ‘pick-ends’ of **4mm**.

For an accurate measurement, place the tool between the teeth at the butt end of the stick.

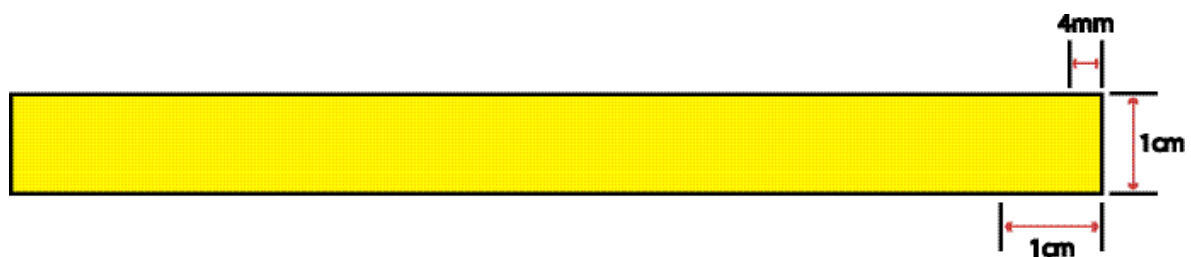

#### 5. Stick curve measurement standard

##### i) measuring tape

The stick is placed horizontally on a flat surface with picks being outside the table. The stick is placed with the curve pointing downwards as shown below.



Measure the height at any point of the blade but only at the lower part of the blade as shown below. The height at any point between the heel and the toe must not be bigger than 1.5 cm. The heel of the stick blade is the point when the blade curves upwards when positioned on a flat surface with a blade pointing downwards.

## Appendix 2: Major rule differences

### 1. Overview

The purpose of this document is to introduce existing able-bodied hockey officials to the sport of Para ice hockey. Although Para ice hockey is basically the same game as able-bodied hockey, there are obvious differences and some subtle differences in the rules and in the way the game is played and officiated.

Outlined in this document are the major rule differences, positioning differences, and other miscellaneous differences.

### 2. Rule differences

For obvious reasons, the kneeling penalty has been removed from the rulebook.

**Rule 1031 – Teeing:** was added to the rulebook as this could not happen in able-bodied hockey. Teeing is defined as ‘a player making contact with an opponent with any part of the front radius of his sledge straight into his opponent’. This does not include all occurrences of contact being made, rather when contact is made at, or almost at right angles of the sledges with significant impact. This is a safety issue for the players as serious injuries can occur.

**Rule 1032 – Tripping:** Any player who uses their stick or arm to push/pull/impede an opponent’s sledge or blades in any manner causing the player to fall to the ice, lose his/her balance, or lose control of his/her sledge

**Rule 1035 – Broken stick:** A player with a broken stick may use any portion of the stick to propel himself to his bench for a replacement, while doing so the player must not participate in the play in any manner.

**Rule 1025 – Holding an opponent:** is probably the most common penalty called in sledge hockey. Holding an opponent for even a moment can cause this player to lose any momentum he may have. Holding can occur on the arms, on the sledge, anywhere on the body, on the head, and even on the opponent's stick.

**Rule 1015 – Butt-ending:** can be extremely dangerous as there are sharp 'picks' at the end of a player's sticks. These 'picks' are used by the players to propel themselves along the ice but are sometimes used as a 'weapon'. Officials should be very alert to a player's use of their sticks.

**Rule 1047 (b) – Falling on the puck by a player:** Often on face-offs, a player will intentionally fall on the puck in order to protect the puck from the opposing centre before passing the puck back to a team mate. This should be strictly enforced with the appropriate minor penalty.

**Rule 903 – Offside:** The determining factors for an offside are 1; the position of the puck and 2; the position of the player's blades. The player must have the blades under his sledge making contact with the blue line at the moment the puck crosses the line.

**Rule 1007 – Penalty Shot:** This rule is the same as the IIHF rulebook with the exception of Note 3 which is the definition of 'from behind'. 'From behind' is determined by the position of the player's body and not by the position of the player's sledge. Even if the player's sledge has come somewhat alongside his opponent's sledge, if his body is still behind his opponent's, then the penalty shot shall be awarded.

**Rule 705 (b) – Change of players procedure during stoppage of play:** Because players are on sledges, 10 seconds is given to the visiting team and the home team to make their player changes instead of the normal 5 seconds. The linesman conducting the face-off will still allow the normal 5 seconds before dropping the puck.

**Rule 902 (b) – Procedure for conducting face-off:** 'The players shall be positioned squarely facing the sideboards of the rink, with their sledges outside of the face-off spot, and with the blade of their stick on the ice on the white part of the face-off spot'. The centre men may face the same way as their opponent or in the opposite direction. After dropping the puck for a face-off, be very aware of the wingers behind you before attempting to back out.

### 3. Positioning procedures and judgment

**Staying on top of the play:** Referees should not hesitate to cross behind the goal net to get closer to the play. When players are battling for a loose puck at close quarters, there are a number of things that can happen including holding (this could be holding the opponent or the opponent's sledge) and jabbing an opponent with the pick end of the stick. Because the players are low to the ice surface while sitting in their sledges, hands and sticks can be hidden behind their opponents so the referee needs to be right on top of the play. This also applies to when the play progresses down the ice. For example, if you see a breakout pass from the end zone in your corner to a breaking player on the other side of the ice, feel free to cross over through the neutral zone to stay on top of the play.

**Moving out from the boards:** The referee has to find open ice during a breakout and when play is moving through the neutral zone. Players on sledges take up more room than able-bodied players so the referee should not be afraid to move away from the boards and move closer to the centre in order to get out of the zone.

**Line change procedure:** When conducting a line change procedure in the end zones, the referee should move out from the end zone corners and make themselves seen by the benches to see if anyone is coming.

**Face-offs:** Officials should conduct the face-off by holding the puck out over the face-off circle at the players' eye level. We do not want the players having to look up to anticipate when the official is going to drop the puck.

**Body checks:** When a player body checks an opponent as they pass each other in opposite directions, the body check must be delivered with the shoulder. Often, a player will put out an elbow or a forearm to deliver the check and this should be penalized as this has a 'clothesline' effect on the player who was checked.

**Judgment on icings:** Linesmen must use a different sense of judgment when washing out an icing because he/she feels that a defending player (other than the goalkeeper) is able to play the puck before it crosses the goal line. A player on a sledge is not able to move as quickly as an able-bodied player so use the appropriate judgment.

**Skating backwards:** It is imperative that you are aware of players behind you before you proceed to back up. If you run into a player on a sledge while skating backwards you will end up on top of the player and hurting that player and/or yourself.

**Linesmen standing outside the blue line:** Linesmen need to be aware that while play is in the attacking zone, defensemen sometimes curl back out into the neutral zone and come back into the attacking zone along the boards. Linesmen will have to give the defenseman

room along the boards by either moving back further into the neutral zone or moving out from the boards to give him room.

**Never, ever jump!** Officials should never jump and they should take the hit and do everything possible not to fall on top of the players. Officials should never jump up on the boards, as the skate blades would then be at the head level of the players.

**Team benches on the ice:** When a game is played at an arena that does not support sledges on the team bench, the players are to sit along the boards in front of the team bench, between the blue line and the centre red line. Penalized players are to sit on the ice in the referee's crease. If a puck is directed toward the team or penalty benches, the players are supposed to direct the puck as if it 'bounced' off the boards. If the puck enters the team bench or if a player has directed the puck in an unfair manner, then blow the play right away. This is a safety issue, as there should not be players fighting for a loose puck among the players on the 'bench'.

## Index

<u>Item</u>	<u>Rule No.</u>
Abuse of official by players	1033
Abuse of official by team officials	1034
Accessories and foot protection	Section 3
Athletes on the ice	702
Bench minor penalty	1002
Benches	204
Blue lines	210
Blocking glove	403
Boards	202
Boarding	1014
Broken stick	1035
Butt-ending	1015
Calling of penalties	1013
Captain and alternate captain complaint	1036
Center line	211
Centre face-off spot and circle	213
Change of players and goalkeepers from the team bench during play	704
Change of players procedure during stoppage of play	705
Change of players from the penalty bench	706
Change of goalkeeper's during stoppage of play	707
Charging	1016
Checking from behind	1017
Checking to the head and neck area	1018
Clock	225
Clothing	Section 4

Competition equipment	Section 5
Coincidental penalties	1011
Curve (of a stick)	Section 3
Cross-checking	1019
Definition of the field of play	200
Definition of a goal	907
Determining the outcome of the game	603
Delay of game - adjustment of equipment	1037
Delay of game - displacing the goal frame	1038
Delay of game - injured player refusing to leave the ice	1039
Delay of game - keeping the puck in motion	1040
Delay of game - late line up	1041
Delay of game - more than one change after goal scored	1042
Delay of game - shooting or throwing the puck outside the playing area	1043
Delay of game - violation of face-off procedures	1044
Delayed offside procedure	904
Delayed penalty	1012
Dimensions of the rink	201
Disallowing a goal	907
Diving	1045
Division and marking of the surface	208
Doors	205
Elbow pads	Section 3
Elbowing	1020
End zone face-off spots and circle	215
End zone nets	207
Excessive roughness	1021



Face-offs	900
Face-off spots and circles	212
Face-off spots and imaginary line	901
Face-off spots in neutral zone	214
Falling on the puck by a player	1047
Falling on the puck by a goalkeeper	1048
Field of play specifications	Section 2
Fisticuffs or roughing	1022
Foot guard/ support	Section 3
Foot protection	Section 3
Fouls against players	Section 10
Front skid	Section 3
Full face masks	Section 3
Game format	Section 6
Game misconduct penalty	1005
Gloves	Section 3
Glass	208
Goal and assist awarded to the player	908
Goal crease	217
Goal frames, posts and netting (goal net)	218
Goal judges- bench	221
Goal lines	209
Goal (Net)	218
Goalkeeper equipment	Section 3
Goalkeeper beyond the center red line	1065
Goalkeeper's clothing	Section 4
Goalkeeper dropping the puck on the goal netting	1068

Goalkeeper's gloves	Section 3
Goalkeeper going to the player's bench during stoppage of play	1066
Goalkeeper's helmet and full face mask	Section 3
Goalkeeper sledge frame	Section 3
Goalkeeper seat	Section 3
Goalkeeper's sticks	Section 3
Goalkeeper leaving the crease during an altercation	1067
Goalkeeper's leg guards	Section 3
Goalkeeper penalty procedure	1010
Handling the puck with hands by a goalkeeper	1050
Handling the puck with hands by a player	1049
Head-butting	1023
Heel support	Section 3
Helmet	Section 3
High sticking the puck	915
High sticking	1024
Hockey stick	Section 3
Holding an opponent	1025
Holding the stick	1026
Hooking	1027
Hybrid icing	905
Ice cleaning	804
Ice rink	Section 2
Icing	906
Illegal or dangerous equipment	1046
Illegal puck	912
Injured goalkeeper's	802

Injured players	801
Interference by spectators	916
Infringement of change of players procedure	1051
Interference with spectators	1052
Kick plate	203
Linesman's signals	Section 11
Major rule differences	Appendix 2
Major penalty	1003
Match penalty	1006
Measurement standards	Appendix 1
Minor penalty	1001
Misconduct penalty	1004
Mouth guard	Section 3
Offside	903
Other penalties	Section 10
Overtime period	604
Penalties	Section 10
Penalty benches	220
Penalties - Definition and procedures	1000
Penalties for goalkeepers	1064
Penalty shot	1007
Penalty shot procedure	1008
Penalty shot shootout	605
Protective glass	206
Player equipment	Section 3
Playing rules	Section 9
Players leaving the penalty or player's bench	1053

Players leaving the penalty bench	1054
Players leaving the benches during an altercation	1055
Prevention of infections by blood	1056
Procedure for conducting face-offs	902
Protection of goalkeeper	1069
Protective equipment	Section 3
Prevention of infections	803
Positioning, procedures and judgment	Appendix 2
Puck	501
Puck on the net	901
Puck out of bounds	909
Puck out of sight	911
Puck striking an official	913
Red and green lights	226
Rink lighting	229
Referee and linesmen signals	Section 11
Referee crease	216
Referee signals	Section 11
Refusing to start play - Team not on the ice	1059
Refusing to start play - Team on the ice	1058
Rule differences	Appendix 2
Safety	Section 8
Scorekeeper's bench	222
Shin protection	Section 3
Shoulder pads	Section 3
Signal and timing devices	223
Siren	224

Skate blades/ Blade carrier	Section 3
Slashing	1029
Sledge frames	Section 3
Sledge seat (Bucket)	Section 3
Spearing	1030
Start of game and periods	601
Sticks and picks	Section 3
Stopping/ Passing the puck with hands	914
Substitution of players and goalkeepers	703
Supplementary discipline	1009
Team benches	219
Team captain	701
Team composition and players in uniform	700
Team officials leaving the player's bench	1057
Teams	Section 7
Teeing	1031
Throat protector	Section 3
Throwing a stick or any object on a breakaway situation	1062
Throwing a stick or any object out of the playing area	1060
Throwing a stick or any object within the playing area	1061
Time-out	602
Timing of game	600
Too many players on the ice	1063
Tripping	1032
Uniforms	Section 3
Unsportsmanlike conduct by players	1033
Unsportsmanlike conduct by team officials	1034





**World Para Ice Hockey**

Adenauerallee 212-214  
53113 Bonn, Germany

Tel. +49 228 2097-200  
Fax +49 228 2097-209

**[info@WorldParalceHockey.org](mailto:info@WorldParalceHockey.org)**  
**[www.WorldParalceHockey.org](http://www.WorldParalceHockey.org)**

© 2018 International Paralympic Committee – ALL RIGHTS RESERVED  
Photo ©: Bob Martin for OIS